

ORAC | LUXXUS



ORAC[®]
DECOR

<http://cebos.com.ua>

Tel.+38-056-3731170

ORAC | LUXXUS

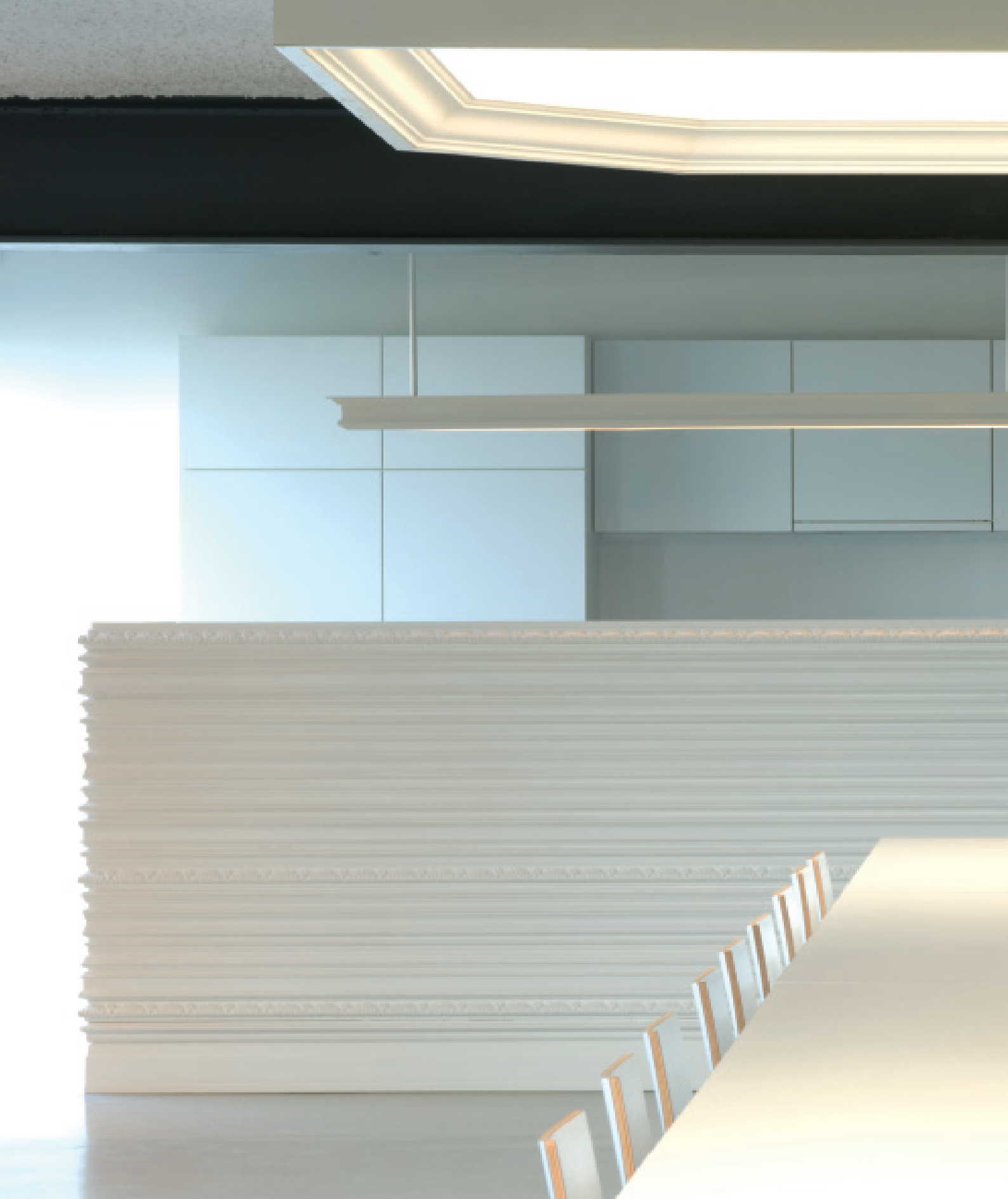





ORAC DECOR®, een merk dat groeit

De ambitie van ORAC DECOR® vandaag? U blijven verrassen. Met decoratieproducten die eruit springen. Zowel in kwaliteit als in innovatie en technologie. Met ruim 35 jaar vakmanschap hebben we natuurlijk een streepje voor. ORAC DECOR® is vandaag dan ook uitgegroeid tot een trendsettend Europees merk van architecturale kunststof-profielen en accessoires.

Maar als gerenommeerd merk hebben we een reputatie hoog te houden. En dus blijven we gedreven zoeken naar nieuwe ideeën, nieuwe technologieën en nieuwe designs om zowel de professionele vakman als de interieurliefhebber decoratieve én functionele oplossingen aan te reiken. Oplossingen die speels kunnen inspireren ook, maar die altijd comfort met gebruiksvriendelijkheid weten te rijmen, kwaliteit met betrouwbaarheid, traditie met vernieuwing.

Om verder te groeien, vertrekken we altijd vanuit een marktgerichte aanpak. Wat leeft er bij de ORAC-community, ons wereldwijde netwerk van professionele installateurs, schilders, architecten, designers en fans tout court?

ORAC DECOR® leeft nu eenmaal van continue vernieuwing. Van gedurfde designs, vernuftige technologieën en creatieve oplossingen. Zo hebben we ons beperkt maar innovatief gamma van de jaren zeventig vandaag vertaald naar een even breed als compleet sfeeraanbod. Daarin speelt ORAC Lxxus een belangrijke rol als premiummerk van luxueuze creatieve profielen en decoratieve accessoires. Aan u om het exclusieve gamma te ontdekken...

ORAC DECOR®, une marque en plein essor

L'ambition d'ORAC DECOR® aujourd'hui? Continuer à vous surprendre! En vous proposant des produits de décoration qui sortent de l'ordinaire. Tant sur le plan de la qualité que de l'innovation et de la technologie. Avec plus de 35 ans d'expérience professionnelle, nous avons une bonne longueur d'avance. ORAC DECOR® s'est ainsi forgé une réputation de marque européenne de premier plan dans le domaine des profilés et accessoires architecturaux en matières synthétiques.

En tant que marque de renom, nous défendons chaque jour notre excellente réputation. Nous sommes en recherche permanente de nouvelles idées, de nouvelles technologies et de nouveaux designs pour pouvoir proposer des solutions décoratives et fonctionnelles au spécialiste professionnel et à l'amateur de décoration intérieure. Des solutions qui inspirent la fantaisie, certes, mais qui associent toujours confort et facilité d'utilisation, qualité et fiabilité, tradition et innovation.

Pour poursuivre notre croissance, notre approche s'axe sur le marché: ce qui anime la communauté ORAC, notre réseau mondial d'installateurs, de peintres, d'architectes, de concepteurs professionnels, et nos fans tout simplement.

ORAC DECOR® est animée par l'innovation continue. Par des designs audacieux, des technologies ingénieuses et des solutions créatives. Dans cet élan, nous avons métamorphosé aujourd'hui notre gamme innovante mais limitée des années soixante-dix en une offre d'ambiance aussi étendue que complète. Dans ce contexte, la série ORAC Lxxus joue un rôle important en tant que marque de qualité supérieure de profilés originaux et d'accessoires décoratifs de luxe. À vous de découvrir cette gamme exclusive...



Guy Tailieu

ORAC | LUXXUS

ORAC LUXXUS, even exclusief als creatief

Binnen het overkoepelende merk ORAC DECOR® neemt ORAC Luxxus een exclusieve plaats in. Het gamma omvat dan ook een uniek aanbod van luxueuze creatieve profielen en decoratieve accessoires. Een compleet gamma voor een totaalconcept in stijl: van kroon- en wandlijsten over plinten en lambrisering tot verlichtings-systemen en deurdecoratie, telkens met dat tikkeltje meer.

De verschillende moulures vinden elkaar in een sterk visuele impact. Zo bepalen ze mee de sfeer binnenshuis met hun opvallende look, hun reliëf of hun opmerkelijke grootte. Kortom, ideaal om een interieur een niet-alledaagse finishing touch te geven. De inspiratieve collectie werd gemakshalve ingedeeld in vier stijlen: country style, contemporary, classic living en royal chic. De volledige lijn wordt bovendien continu aangevuld met vernieuwende ideeën en creaties van topdesigners.

Niet alleen een buitengewoon design maar ook een onberispelijke kwaliteit kenmerkt ORAC Luxxus. De moulures zijn vervaardigd van kwalitatieve kunststoffen als Purotouch® (hoogwaardig polyurethaan) en Duropolymer® (een polymeer met hoge dichtheid). Materialen die hun kwaliteit ruimschoots bewezen hebben én die een vlotte plaatsing toelaten.

ORAC LUXXUS, exclusive et créative

Occupant une place exclusive dans la marque ORAC DECOR®; la gamme ORAC Luxxus comprend une offre inouïe de profilés créatifs et d'accessoires décoratifs de luxe: moulures de plafond et murales, plinthes, lambris, décorations de portes et systèmes d'éclairage... Bref, une gamme complète pour un concept total esthétique, qui se distingue par son style.

Combinées, les différentes moulures ont un impact visuel puissant et élégant. Originales, travaillées ou monumentales, elles contribuent à définir l'atmosphère de votre intérieur, à lui donner l'accent qui fera sa finition magistrale. Pour votre facilité, cette collection pleine d'inspiration a été subdivisée en quatre styles: country living, contemporary, traditional style et royal chic. La gamme étendue est complétée en permanence par des idées et créations innovantes de concepteurs de pointe.

La gamme ORAC Luxxus se distingue par son design exceptionnel et sa qualité irréprochable. Les moulures sont fabriquées dans des matières synthétiques de qualité supérieure, telles que le Purotouch® (un polyuréthane haut de gamme) et Duropolymer® (un polymère haute densité). Des matériaux dont la qualité éprouvée autorise un placement rapide.

algemene inhoud
contenu général

011.
STYLE GUIDE
STYLE GUIDE

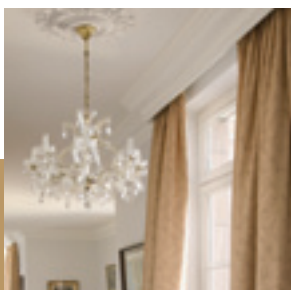

078.
PRODUCTEN
PRODUITS



135.
TECHNISCHE INFO
INFOS TECHNIQUES



ORAC | LUXXUS

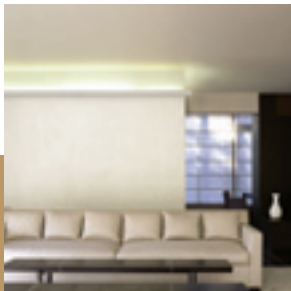

CONTEMPORARY

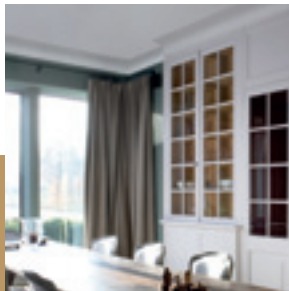

COUNTRY STYLE

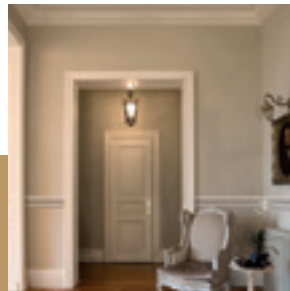

CLASSIC LIVING

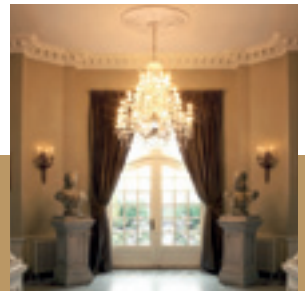

ROYAL CHIC





contemporary

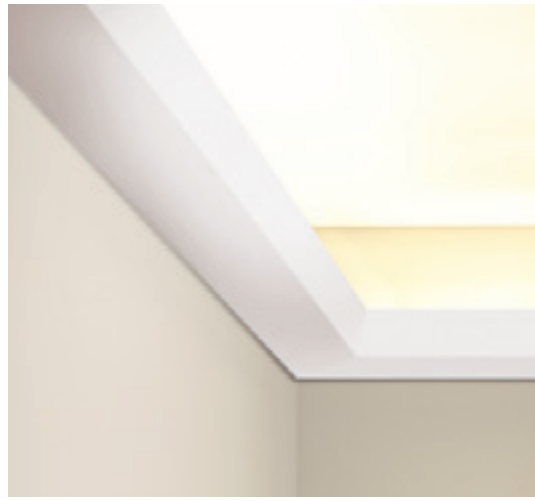

VERLICHTING
ECLAIRAGE
C357









VERLICHTING
ECLAIRAGE
C358

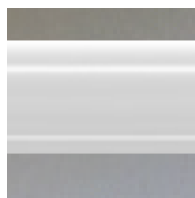

PLINT
PLINTHE
SX104

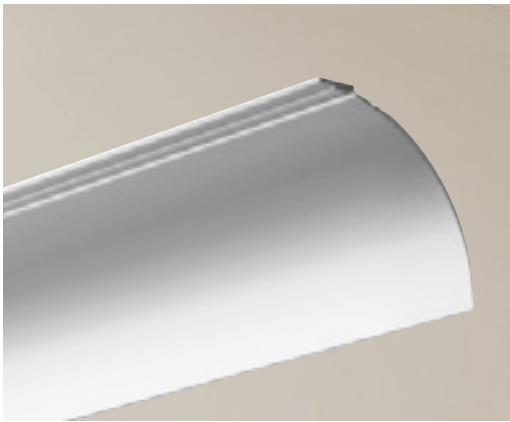

WANDLIJST
CIMAÏSE
P9900

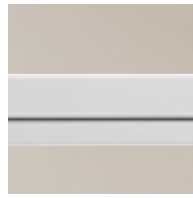

KROONLIJST
CORNICHE
C990

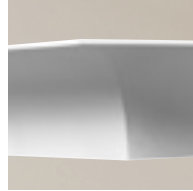

PLINT
PLINTHE
SX118

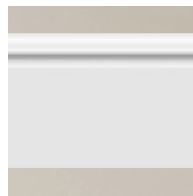







KROONLIJST
CORNICHE
C353

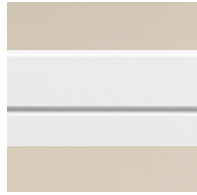

PLINT
PLINTHE
P5051



KROONLIJST
CORNICHE
C356

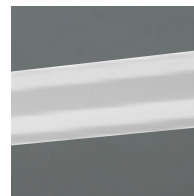

VERLICHTING
ECLAIRAGE
L600-001

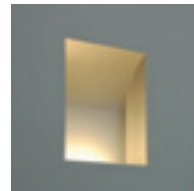

PLINT
PLINTE
SX104









VERLICHTING
ECLAIRAGE
C352





country style

KROONLIJST
CORNICHE
C990



PLINT
PLINTHE
SX118

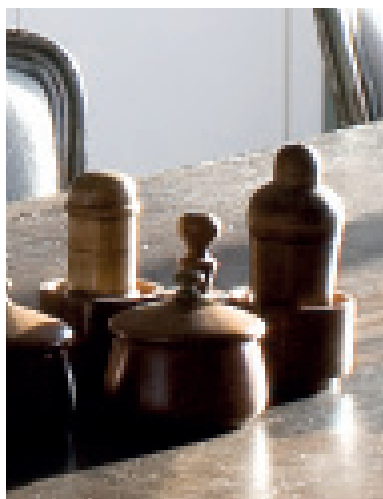
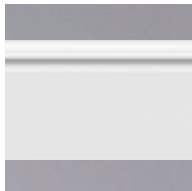





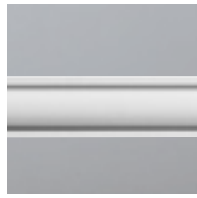

WANDLIJST
CIMAISE
P9901



KROONLIJST
CORNICHE
C990

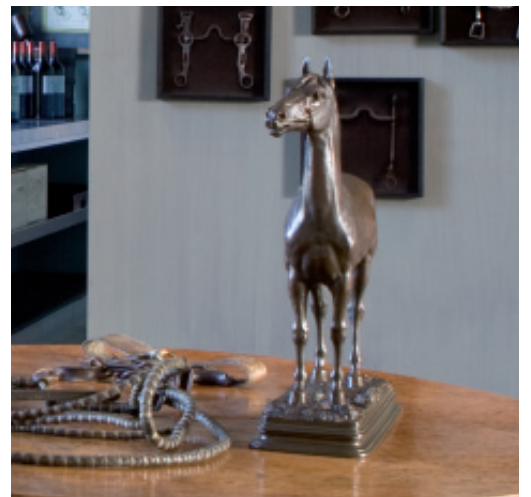
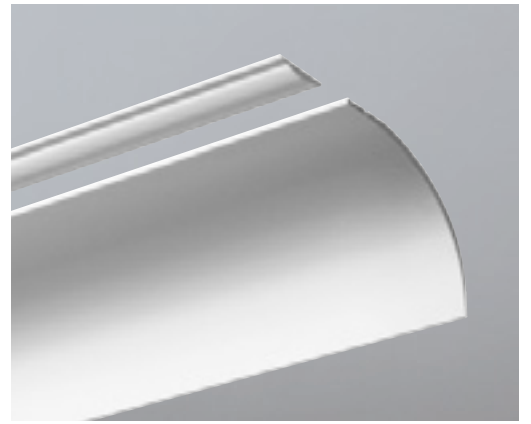

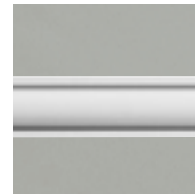
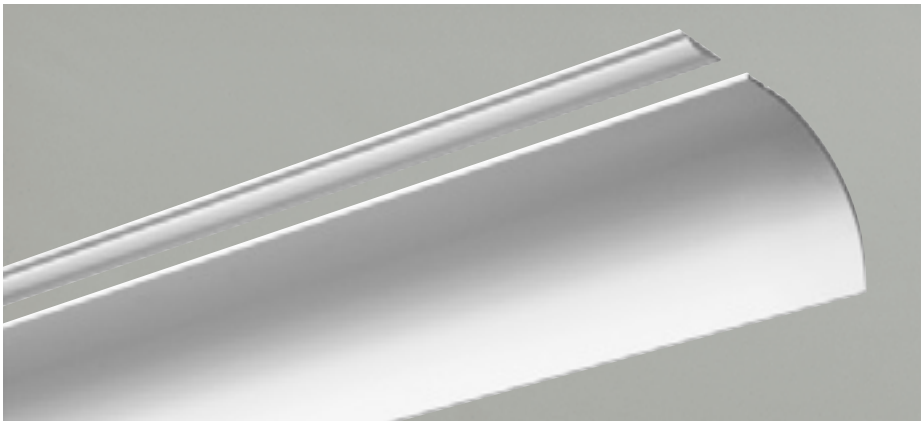

WANDLIJST
CIMAISE
P9901

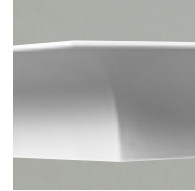

KROONLIJST
CORNICHE
C990

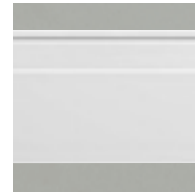

PLINT
PLINTHE
SX156







WANDLIJST
CIMAISE
P9900

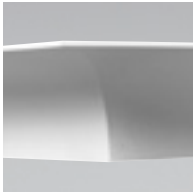

KROONLIJST
CORNICHE
C990

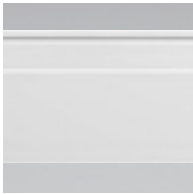

PLINT
PLINTHE
SX156

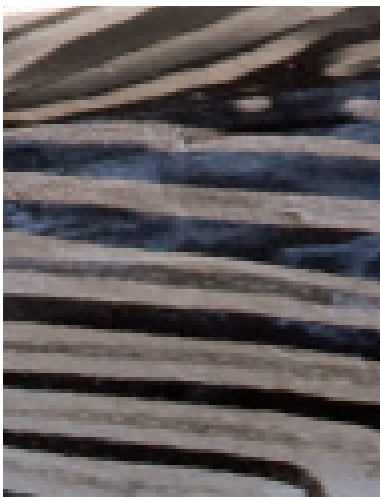
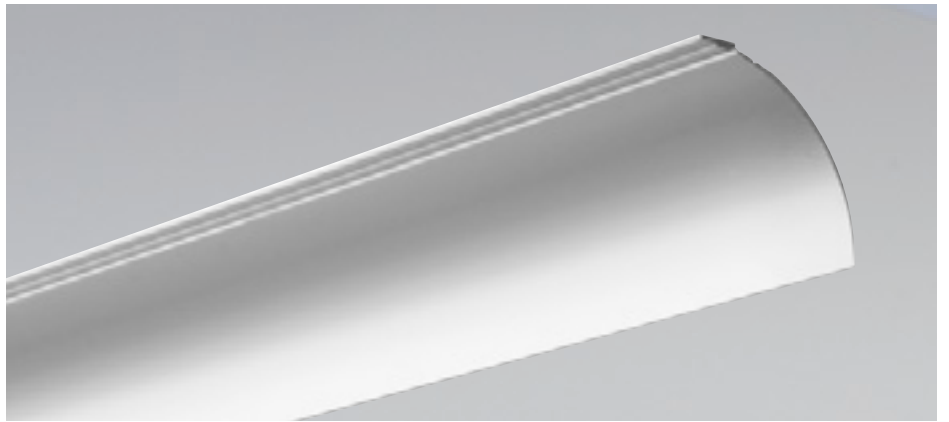



BYBLOS
BYBLOS
M9010 L/R



BYBLOS
BYBLOS
M9010 A



BYBLOS
BYBLOS
M9010 B



WANDLIJST
CIMAISE
P9010

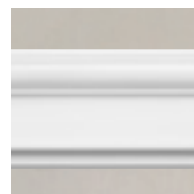

WANDLIJST
CIMAISE
P8030



PANEEL
PANNEAU
D503



PLINT
PLINTHE
SX 156







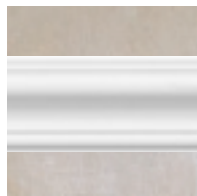

WANDLIJST
CIMAISE
P8020

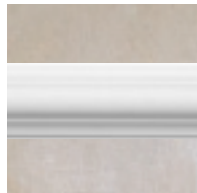

WANDLIJST
CIMAISE
P4020



WANDLIJST
CIMAISE
P4020 A

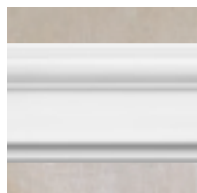

DEUROMLIJSTING
HABILLAGE DE
PORTES
P9010



VOETSTUK
PIEDESTAL
D300



PANEEL
PANNEAU
D503



PANEEL
PANNEAU
D504

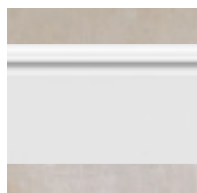

PLINT
PLINTHE
SX118





classic living





KROONLIJST
CORNICHE
C335

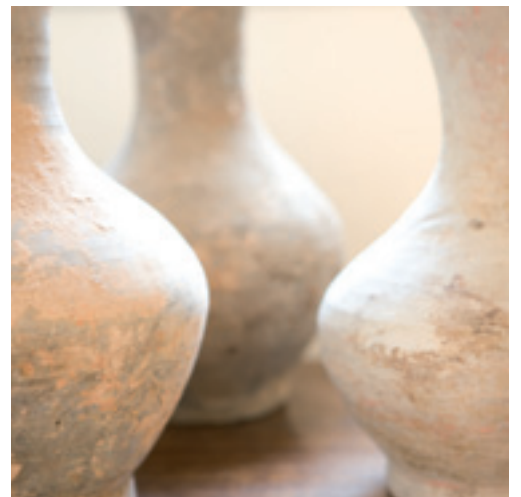

KROONLIJST
CORNICHE

C335

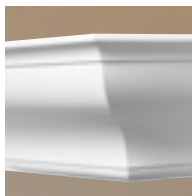

WANDLIJST
CIMAISE

P8050

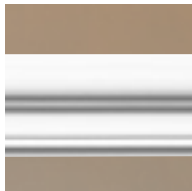

PLINT
PLINTHE

SX155

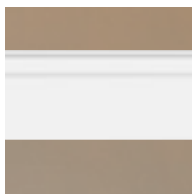







KROONLIJST
CORNICHE
C334



ROZAS
ROSACE
R17

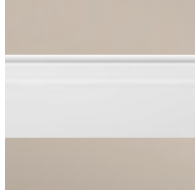

PLINT
PLINTHE
SX155



KROONLIJST
CORNICHE
C333



ROZAS
ROSACE
R74

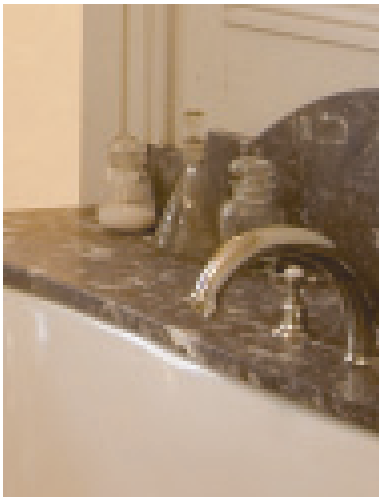





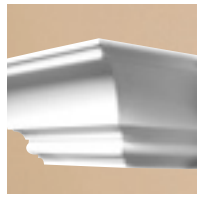

KROONLIJST
CORNICHE
C336



WANDLIJST
CIMAISE
P8050



PLINT
PLINTHE
SX156



KROONLIJST
CORNICHE
C332









KROONLIJST
CORNICHE
C217



WANDLIJST
CIMAISE
P8030



KROONLIJST
CORNICHE

C217



PLINT
PLINTHE

SX118

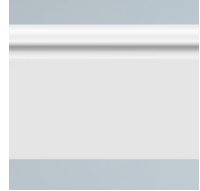



WANDLIJST
CIMAISE
P7070 F



KROONLIJST
CORNICHE
C240 F



ROZAS
ROZACE
R40



WANDLIJST
CIMAISE
P4020 F

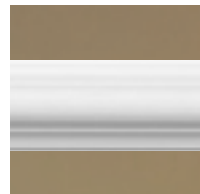

PLINT
PLINTHE
SX118 F

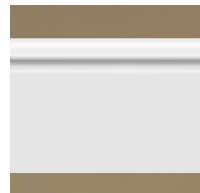







royal chic



KROONLIJST
CORNICHE
C307/C307A



ROZAS
ROSACE
R52

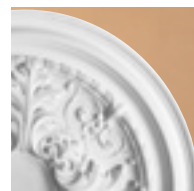

KAPITEL
CHAPITEAU
K1142



SCHACHT
COLONNE
K1102



VOETSTUK
PIEDESTAL
K1152









KROONLIJST
CORNICHE
C217



ROZAS
ROSACE
R64

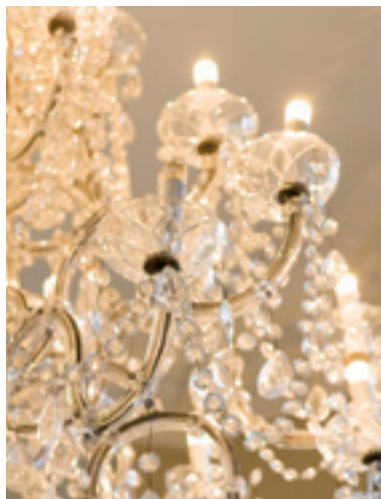





KROONLIJST
CORNICHE
C901

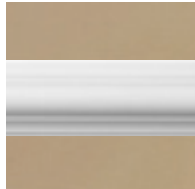

WANDLIJST
CIMAISE
3X P4020



WANDLIJST
CIMAISE
P7020



SIERELEMENT
ÉLÉMENT
DÉCORATIF
G40/G41



KROONLIJST
CORNICHE
C336

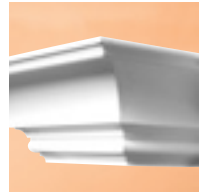

ROZAS
ROSACE
R64

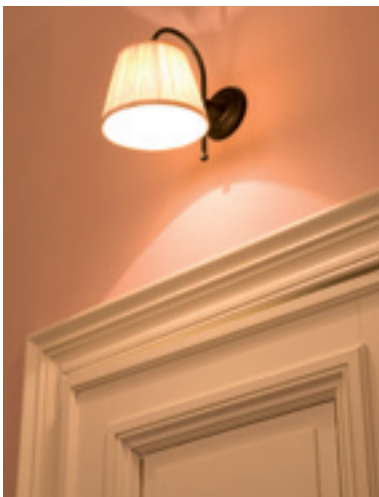





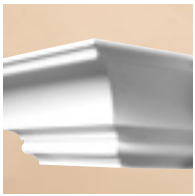

KROONLIJST
CORNICHE
C336



WANDLIJST
CIMAISE
P8050



WANDLIJST
CIMAISE
P8020



PLINT
PLINTHE
SX156



KROONLIJST
CORNICHE
C217/C217F



PLINT
PLINTHE
SX118/SX118F

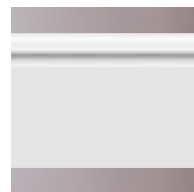





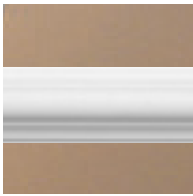

WANDLIJST
CIMAISE
P4020

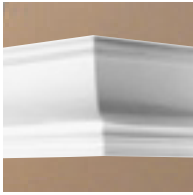

KROONLIJST
CORNICHE
C900



FRONTON
FRONTON
D401 + D402+ K200 + D320

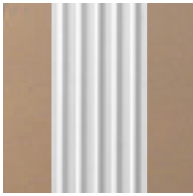

PILASTER
PILASTRE
K200

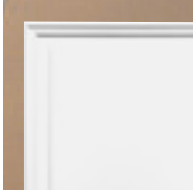

PANEEL
PANNEAU
D507



WANDLIJST
CIMAISE
P7030



WANDLIJST
CIMAISE
DX121

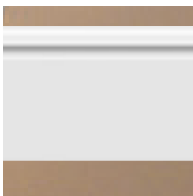

PLINT
PLINTHE
SX118



VOETSTUK
PIEDESTAL
K202



KROONLIJST
CORNICHE
C422

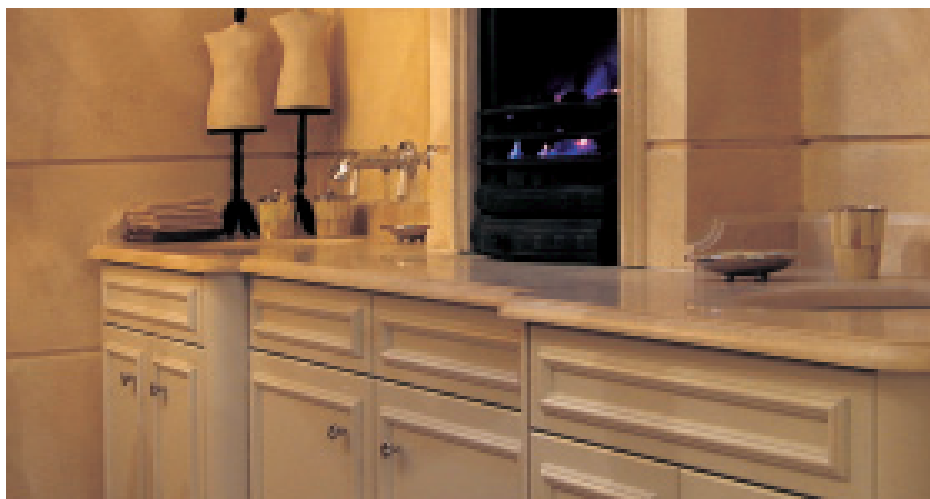
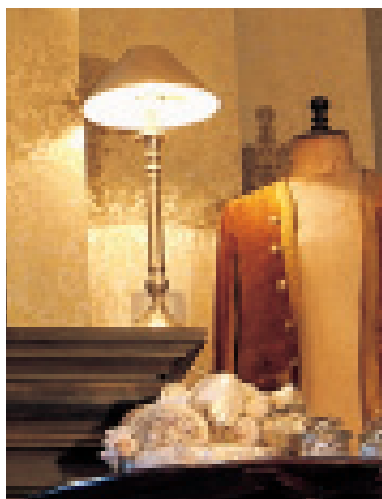





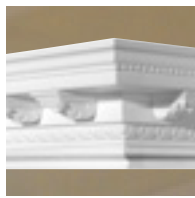

KROONLIJST
CORNICHE
C307/C307A

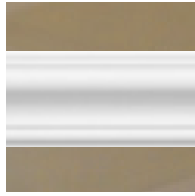

PLINT
PLINTHE
P8020

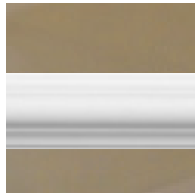

PLINT
PLINTHE
P4020



WANDLIJST
CIMAISE
P21



ROZAS
ROSACE
R09

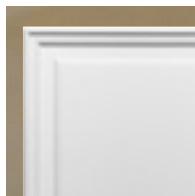

PANEEL
PANNEAU
D503/D504



KAPITEL
CHAPITEAU
K201

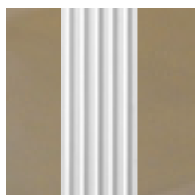

PILASTER
PILASTRE
K200



VOETSTUK
PIEDESTAL
K202



overzicht productgroepen
tableau des produits

080.
KROONLIJSTEN
CORNICHES



092.
WANDLIJSTEN
CIMAISES

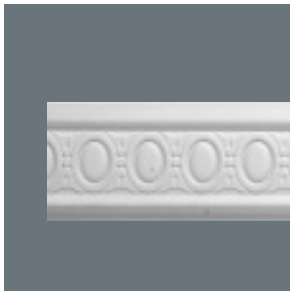

096.
PLINTEN
PLINTHES



098.
ORAC FLEX
ORAC FLEX



100.
BYBLOS
BYBLOS



DEUROMLIJSTINGEN
ENCADREMENTS DE PORTES
102.



PANELEN
PANNEAUX
104.



FRONTONS
FRONTONS
108.



ROZASSEN
ROSACES
110.

114.
PLAFONDDECORATIE
DÉCORATION DE PLAFONDS



116.
SCHAPPEN & CONSOLEN
ÉTAGÈRES ET CONSOLES



117.
SIERSCHOUWEN
CHEMINÉES DÉCORATIVES



118.
NISSEN - SIERELEMENTEN
NICHES - ÉLÉMENTS DÉCORATIFS



PILASTERS
PILASTRES
120.



ZUILEN
COLONNES
122.



VERLICHTING
ÉCLAIRAGE
127.



TECHNISCHE INFO
INFOS TECHNIQUES
135.

ORAC XTERIO: konsolen voor buitentoepassingen: prijzen en info op aanvraag.

ORAC XTERIO: habillage de façade extérieure: prix et info sur demande.

glad
lisses

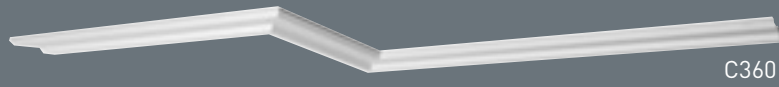

C360



C356



C353

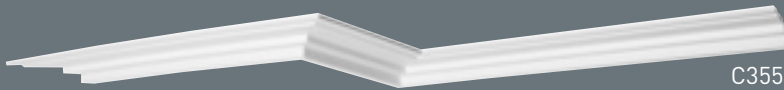
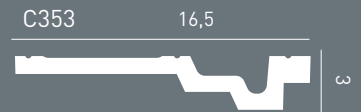

C355



C354

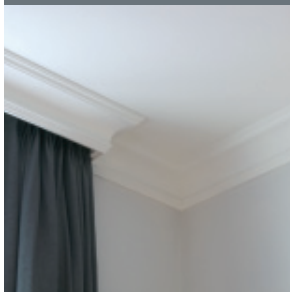

C217

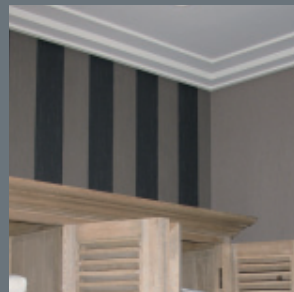

C354

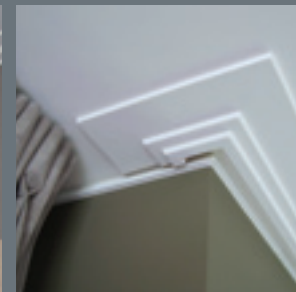

C353

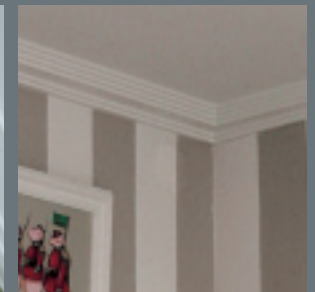

C400

KROONLIJSTEN
CORNICHES

L: 200cm

DESIGNED BY: J. VERGRACHT: C353, C354, C355, C356, C360

© REGISTERED DESIGN: C356, C353, C355, C354



C250/C250F



C230/C230F



C260/C260F

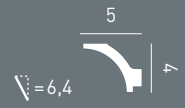

C305/C305F

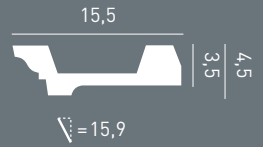

C215/C215F



C322/C322F



C602/C602F



ref+F = verkrijgbaar in flexibele uitvoering, zie p.98.

réf+F = disponible en flex, voir p.98.

glad
lisses

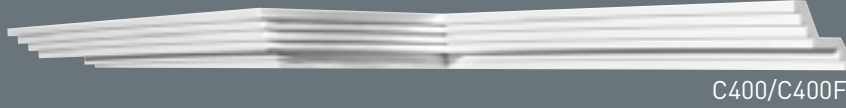

C400/C400F

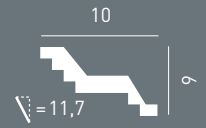

C331/C331F

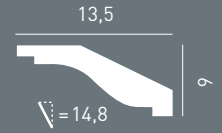

C200/C200F



C220/C220F

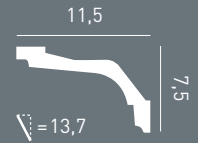

C213/C213F



C240/C240F

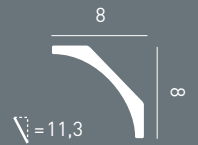

KROONLIJSTEN
CORNICHES

L: 200cm



C321/C321F

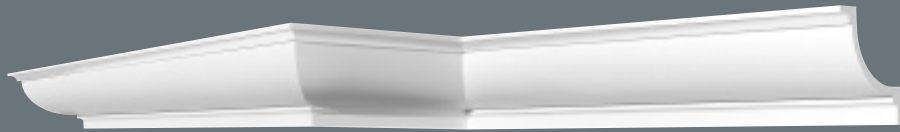
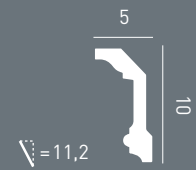

*C902/C902F

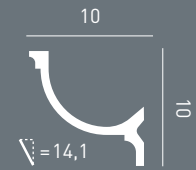

C217/C217F

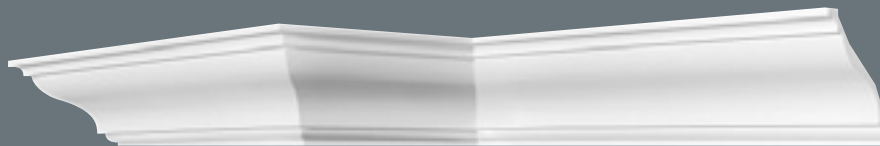
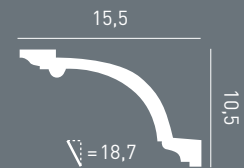

C333/C333F

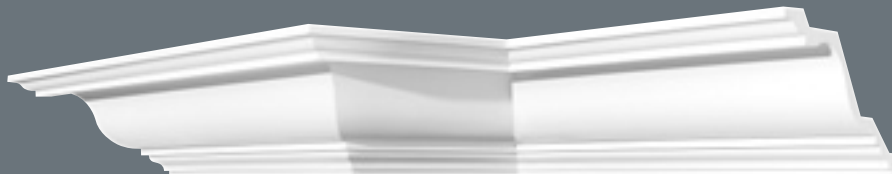
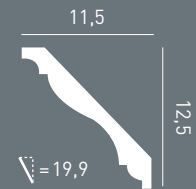

C334/C334F

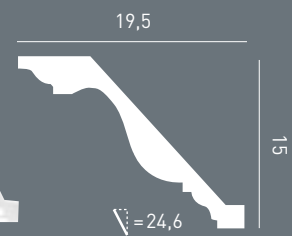

ref+F = verkrijgbaar in flexibele uitvoering, zie p. 98.
* zie indirecte verlichting, p. 127.

réf+F = disponible en flex, voir p. 98.
* voir éclairage indirect, p. 127.

glad
lisses

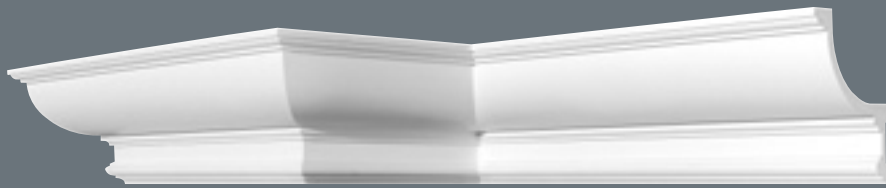

*C901/C901F

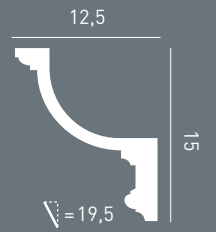

C217/C217F

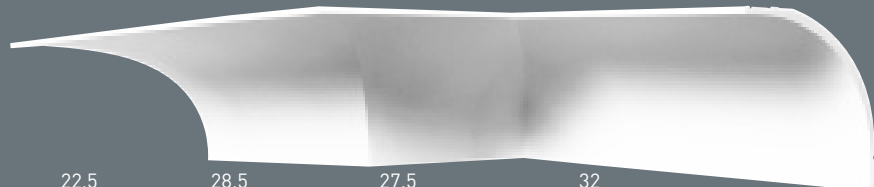

C990

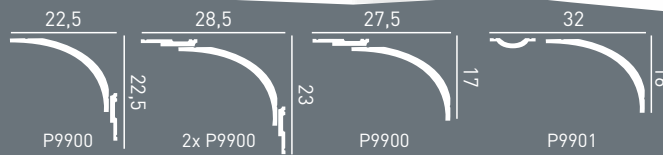

NEW

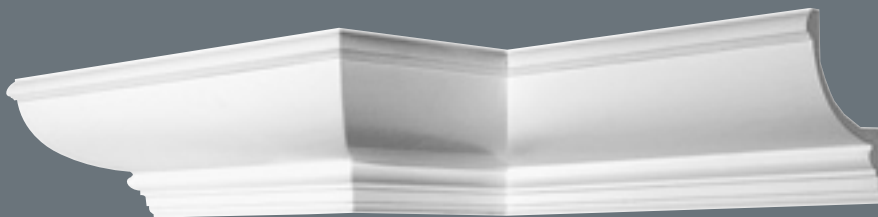
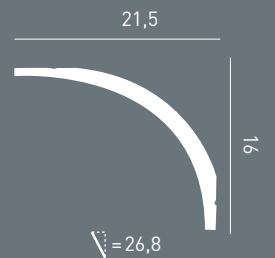

*C900

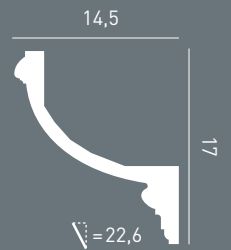

C300

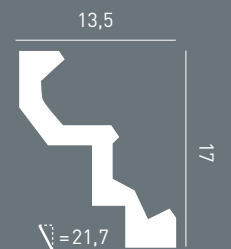

KROONLIJSTEN
CORNICHES

L: 200cm

ref+F = verkrijgbaar in flexibele uitvoering, zie p. XXX.
* zie indirecte verlichting, pagina XXX

réf+F = disponible en flex, voir p.XXX.
* voir éclairage indirect, page XXX

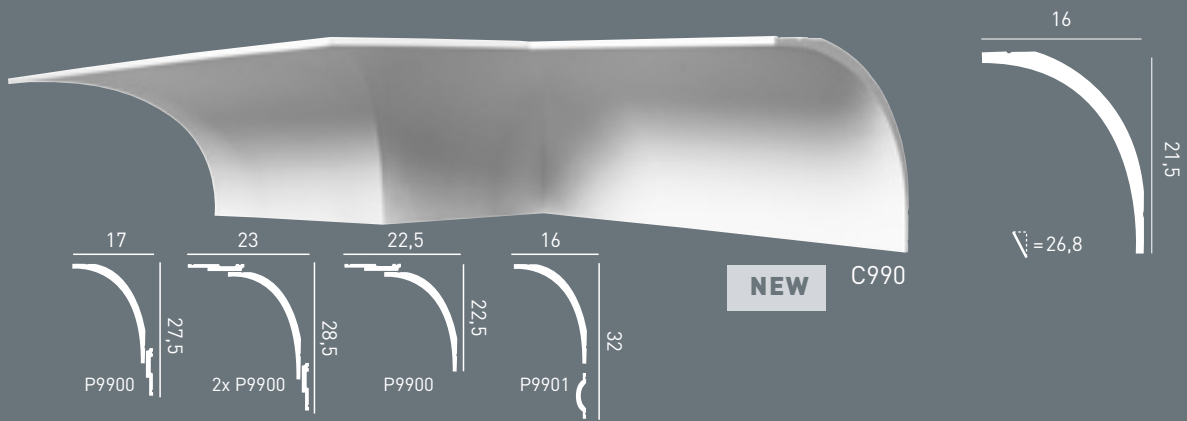

NEW

C990

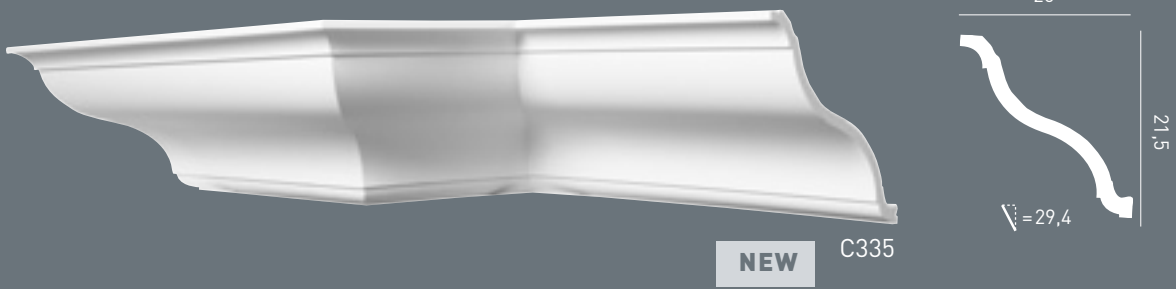

NEW

C335



C332

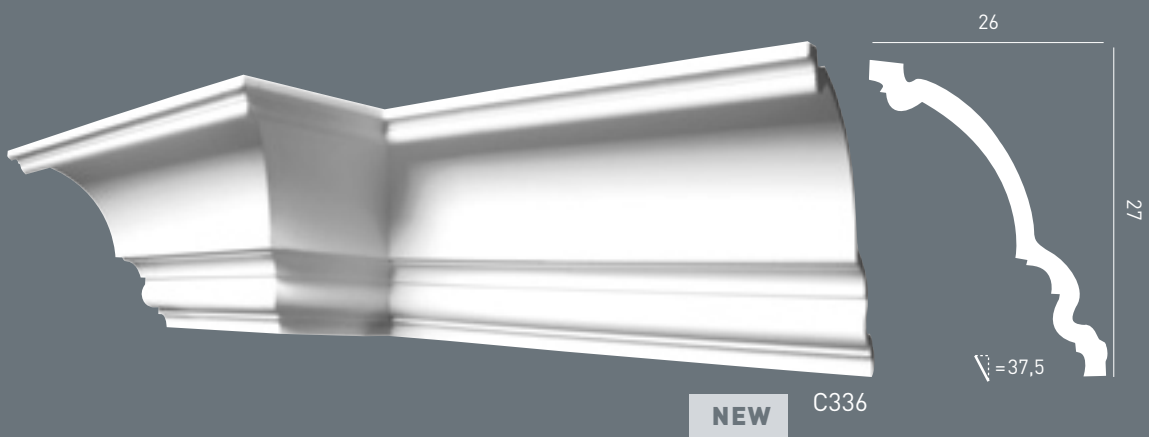

NEW

C336

DESIGNED BY: X. DONCK: C335, C990, P9900, P9901

© REGISTERED DESIGN: C990, P9900, C335, C336, P9901

geornamenteerd
à motifs



C214/C214F



C212/C212F

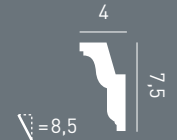

C402/C402F

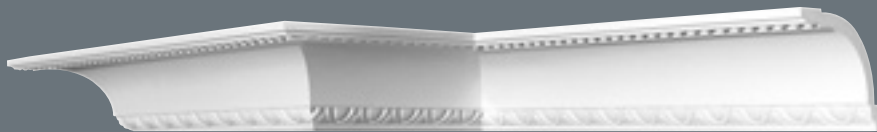
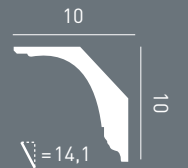

C216/C216F

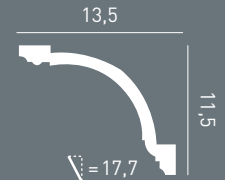

C201/C201F

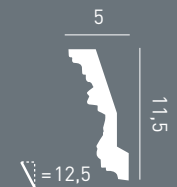

C301

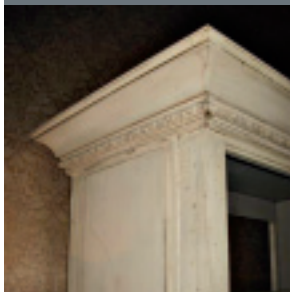

C422, C211

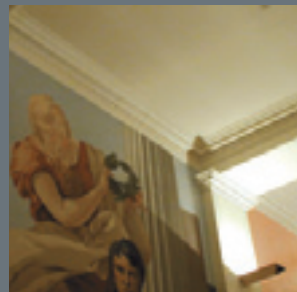

2x P4020 + C901 + P7020



C302

KROONLIJSTEN
CORNICHES

L: 200cm

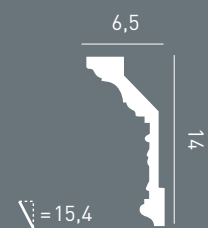
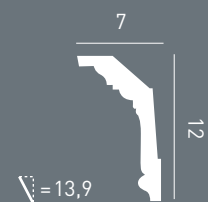
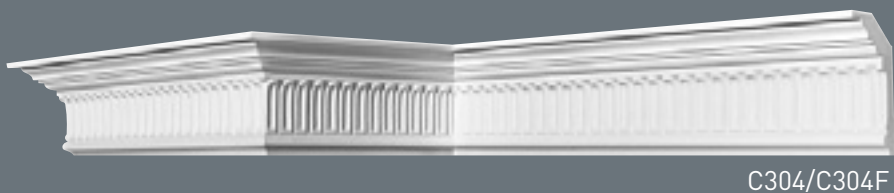
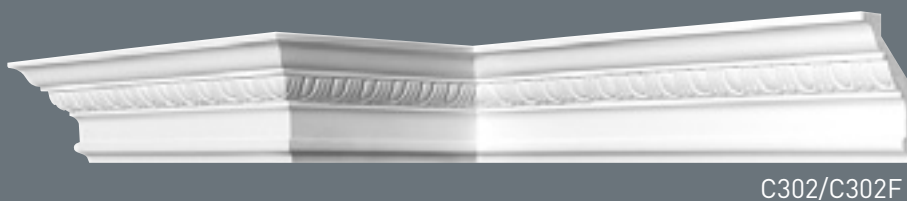
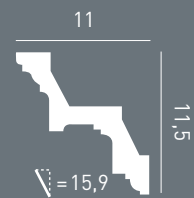

ref+F = verkrijgbaar in flexibele uitvoering, zie p.98.

réf+F = disponible en flex, voir p.98.

geornamenteerd
à motifs



C218/C218F

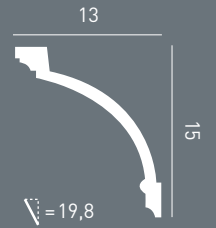

C422

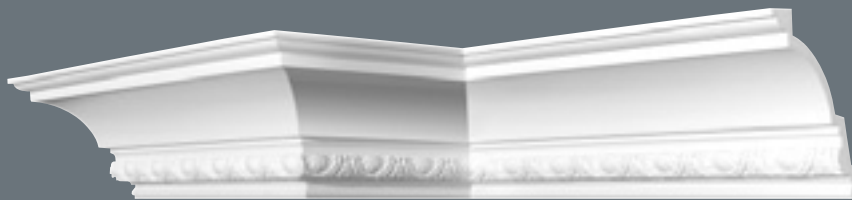

C301/C301F

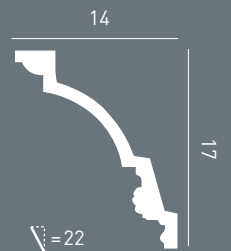

C219



KROONLIJSTEN
CORNICHES

L: 200cm



C307

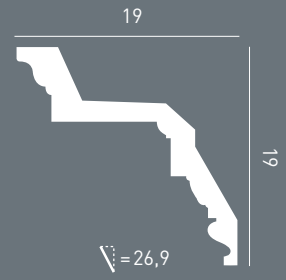

C307 + C307A



15cm



C307A
7,5 x 9,5 x 4cm



C308/C308F

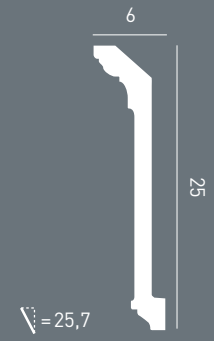

ref+F = verkrijgbaar in flexibele uitvoering, zie p.98.

réf+F = disponible en flex, voir p.98.

glad
lisses

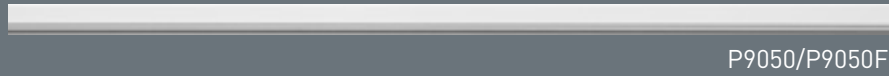

P9050/P9050F



P5021/P5021F



P8030/P8030F



P4020/P4020F



P9040/P9040F



P8020/P8020F



NEW

P9901/P9901F

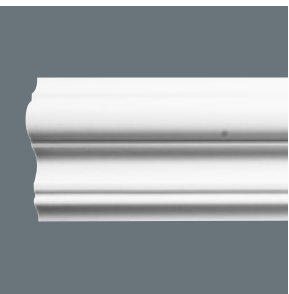

P8040, P21

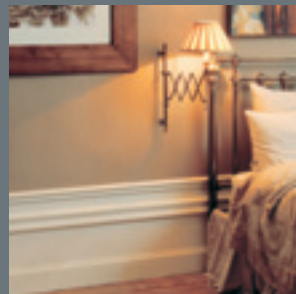

P8020, P8040

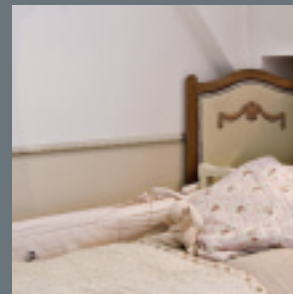

P2020

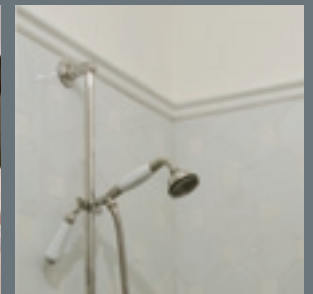

P8020

WANDLIJSTEN
CIMAISES

L: 200cm

DESIGNED BY: X. DONCK: P9900, P9901

DESIGNED BY: J. VERGRACHT: P5051

© REGISTERED DESIGN: P9901/P9901F, P9900/P9900F, P5051



ref+F = verkrijgbaar in flexibele uitvoering, zie p.98.

réf+F = disponible en flex, voir p.98.

glad
lisses

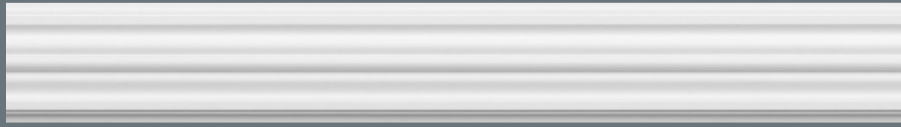

P9020/P9020F

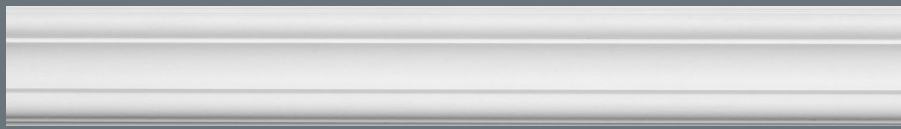

P8040/P8040F



NEW

P8050/P8050F

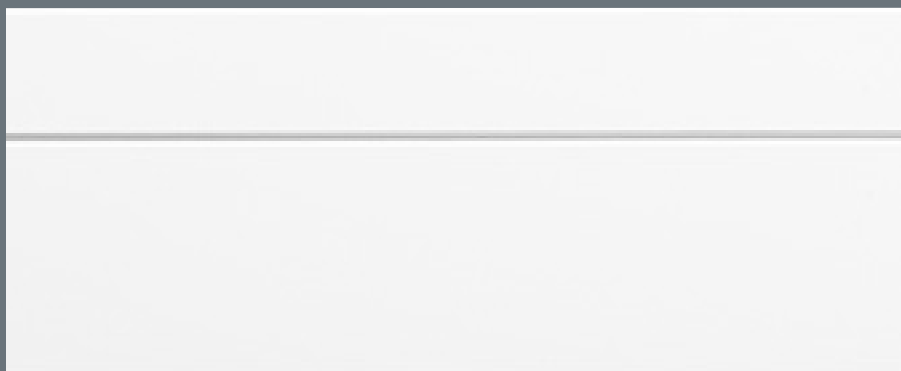

P5050



WANDLIJSTEN
CIMAISES

L: 200cm

DESIGNED BY: X. DONCK: P8050

DESIGNED BY: J. VERGRACHT: P5050

© REGISTERED DESIGN: P5050, P8050/P8050F

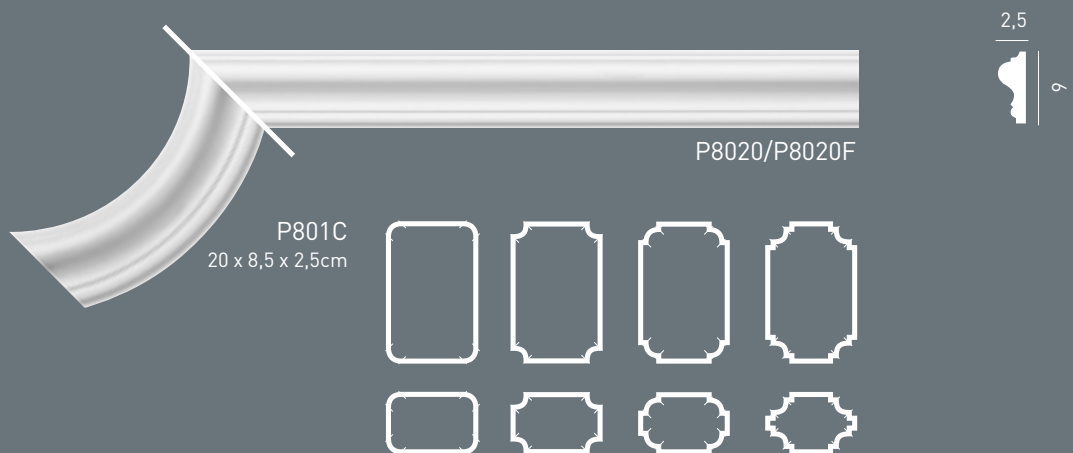
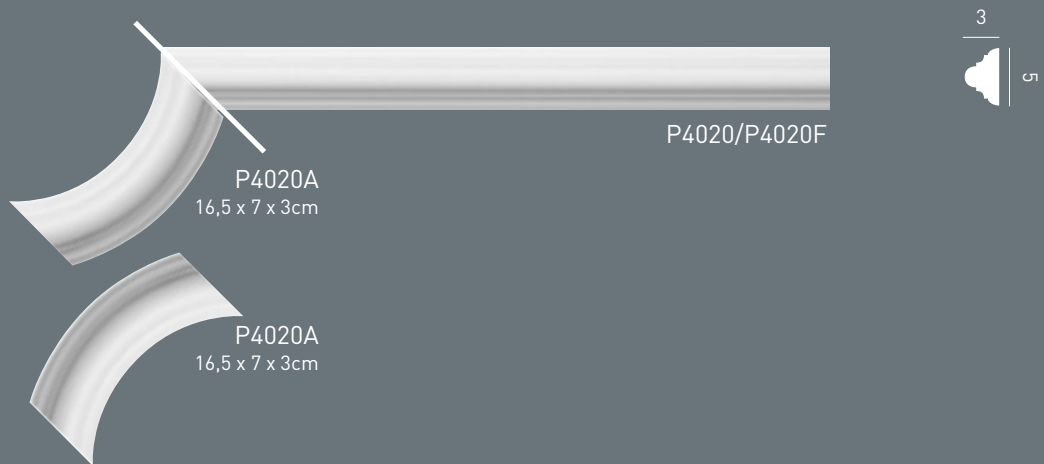
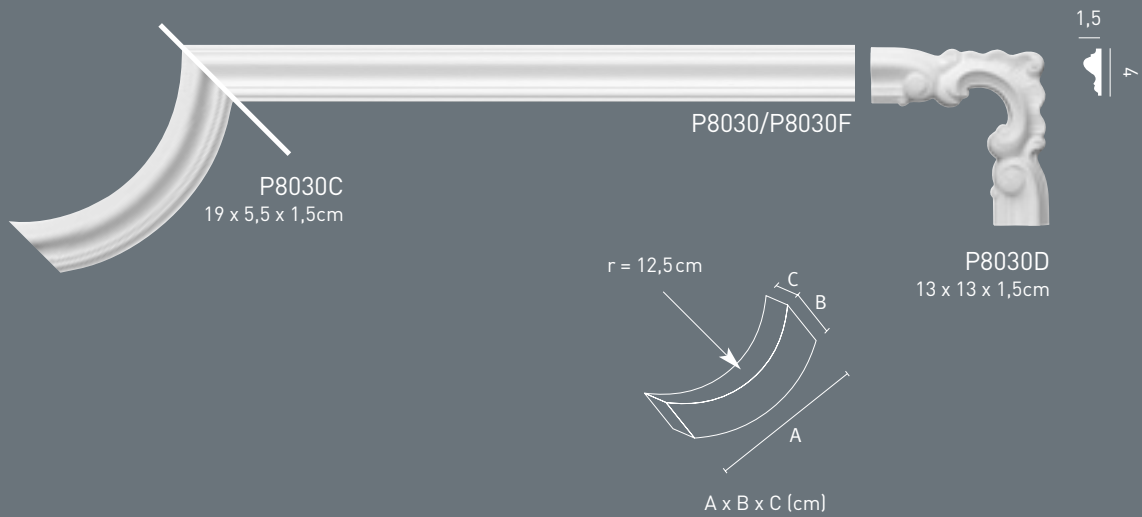

ref+F = verkrijgbaar in flexibele uitvoering, zie p.98.

réf+F = disponible en flex, voir p.98.

geornamenteerd
à motifs



P2020/P2020F



P1020/P1020F



P7050/P7050F



P3020/P3020F



P6020/P6020F



P7060/P7060F



P7040/P7040F



P7030/P7030F

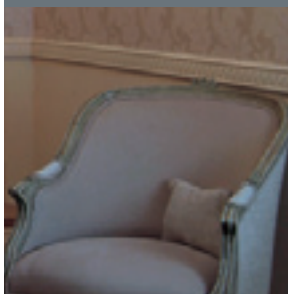

P7030



P7080

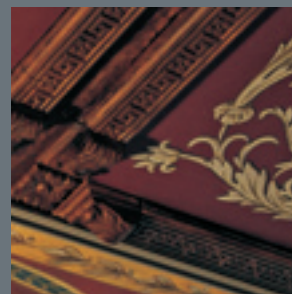

P7060



P8030(D), P4020, P20

WANDLIJSTEN
CIMAISES

L: 200cm



P7010/P7010F



P7020/P7020F



P7080



P21
6,5 x 6,5 x 1 cm



P2020/P2020F

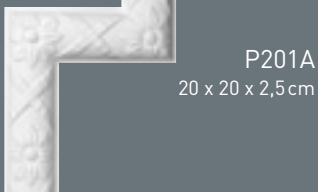

P201A
20 x 20 x 2,5 cm

P20
Ø6,5 x 1 cm



P1020/P1020F

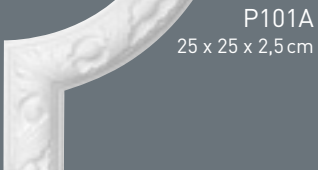

P101A
25 x 25 x 2,5 cm

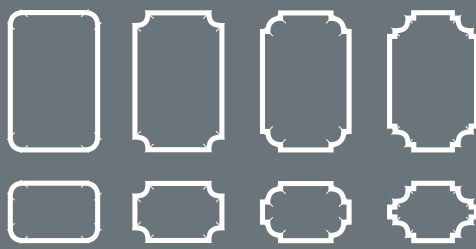

ref+F = verkrijgbaar in flexibele uitvoering, zie p.98.

réf+F = disponible en flex, voir p.98.

stootvast en waterbestendig
antichoc et résistant à l'eau

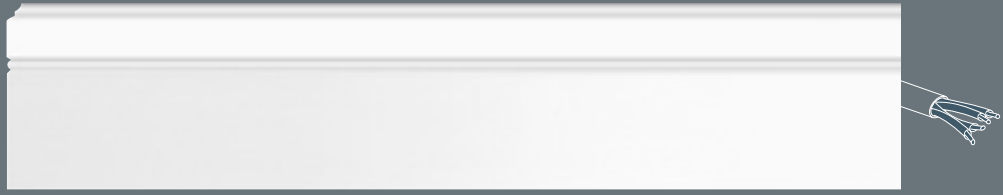

SX105/SX105F

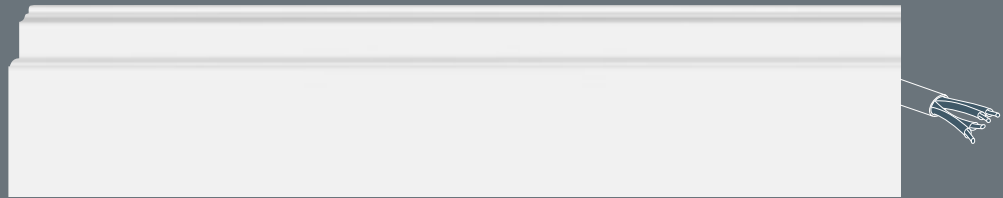

SX155/SX155F

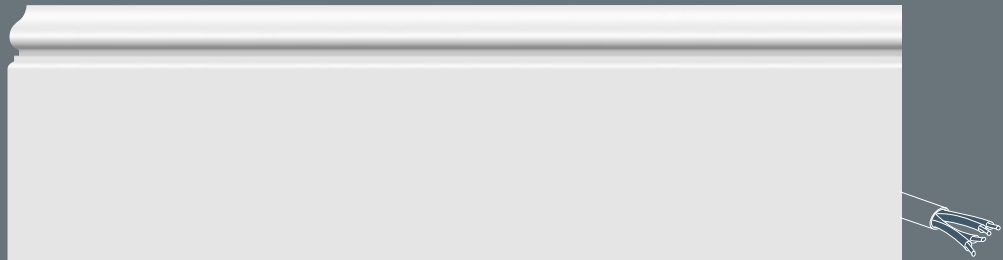

SX118/SX118F

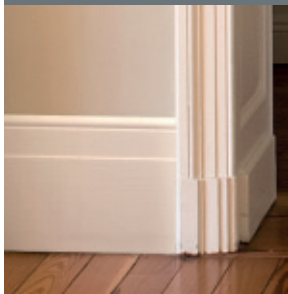

SX156

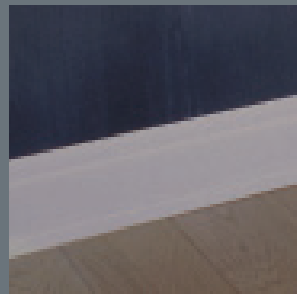

SX104



SX138



SX118/SX118F

PLINTEN
PLINTHES

L: 200cm

ref+F = verkrijgbaar in flexibele uitvoering, zie p. XXX.

réf+F = disponible en flex, voir p.XXX.

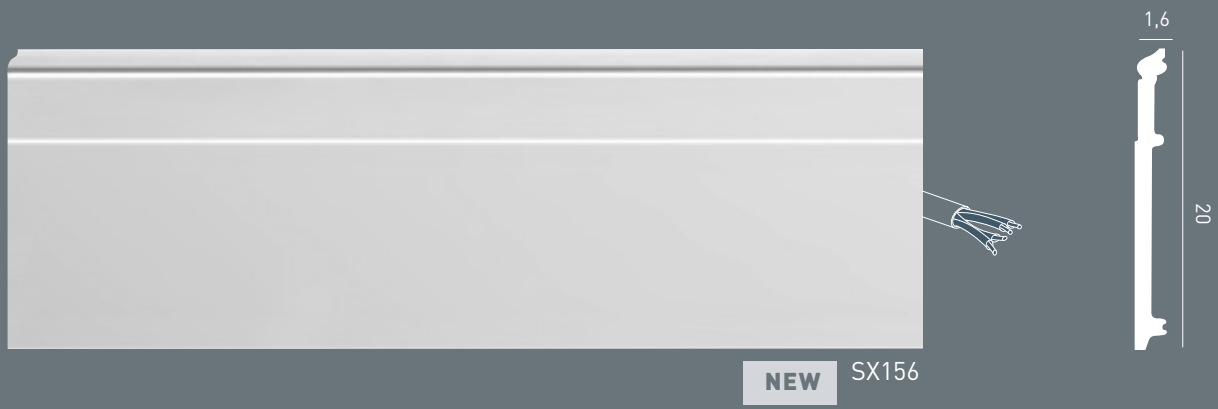
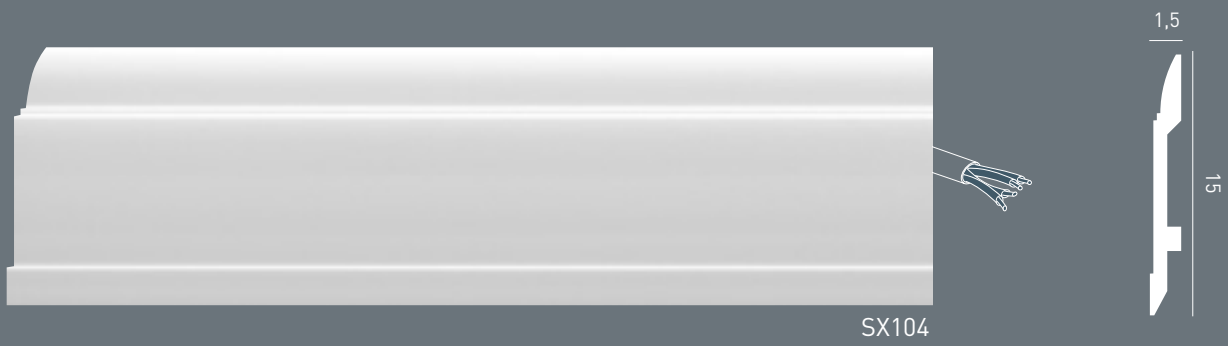

ORAC | AXSENT

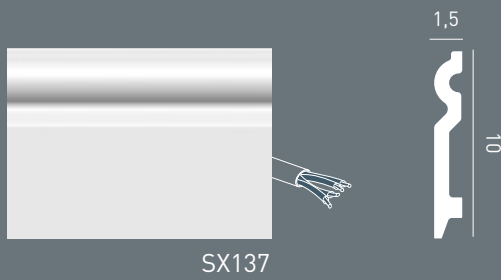
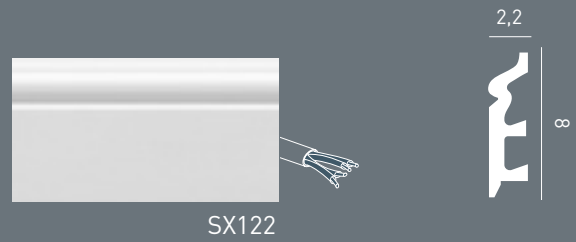
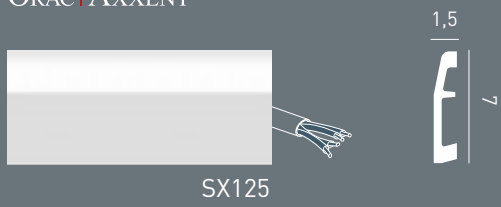

DESIGNED BY: X. DONCK: SX 156

® REGISTERED DESIGN: SX156

flexibele lijsten
moultures flexibles



ORAC FLEX
ORAC FLEX

ORAC FLEX, DE STIJLVOLLE OPLOSSING VOOR GEBOGEN EN AFGERONDE MUREN ORAC FLEX, LA SOLUTION ÉLÉGANTE POUR LES MURS CINTRÉS ET ARRONDIS

Hierbij een overzicht van alle Orac Luxxus wand- en kroonlijsten en plinten die in flexibele polyurethaan gerealiseerd kunnen worden. Door deze buigzaamheid kunnen gebogen wanden en plafonds elegant afgewerkt worden. Men kan ook gebogen ornamenten op een vlakke wand of plafond aanbrengen. De flexibele lijsten zijn op dezelfde manier af te werken als de gewone lijsten.

Installatieinstructies zijn verkrijgbaar.

Voici une aperçu des corniches, cimaises et plinthes Orac Luxxus existantes qui sont réalisées dans un polyuréthane flexible. Par leur souplesse, elles permettent de décorer les murs et plafonds arrondis. Ces moulures peuvent être décorées de la même façon que les autres moulures.

Des modes d'emploi sont disponibles.

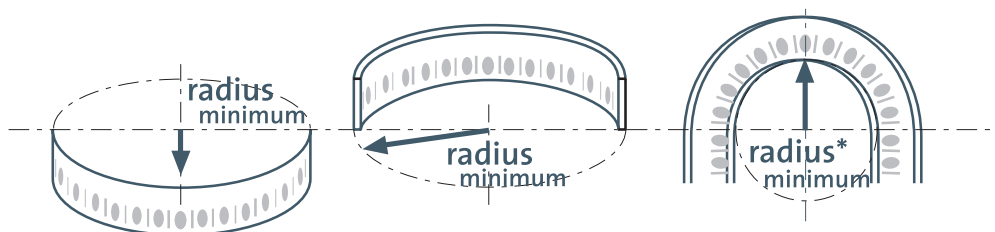

voor perfecte installatie:
pour une installation parfaite:



(zie pg. 140)
(voir page 140)

KROONLIJSTEN - CORNICHES

	Rmin	R*min
C200F	1,2 m	
C201F	0,8 m	/
C211F	2,5 m	/
C212F	1,4 m	/
C213F	1,8 m	/
C214F	1,0 m	/
C215F	1,6 m	/
C216F	3,4 m	/
C217F	3,4 m	/
C218F	3,5 m	/
C220F	2,0 m	/
C230F	1,0 m	/
C240F	2,0 m	/
C250F	0,8 m	/
C260F	1,3 m	/
C301F	3,0 m	/
C302F	2,6 m	/
C303F	1,8 m	/
C304F	1,8 m	/
C305F	3,4 m	/
C308F	1,4 m	/
C321F	1,4 m	/
C322F	1,2 m	/
C331F	4,2 m	/
C333F	3,3 m	/
C334F	3,8 m	/
C400F	3,0 m	/
C402F	1,5 m	/
C602F	1,3 m	/
C901F	3,8 m	/
C902F	3,8 m	/

WANDLIJSTEN - CIMAISES

	Rmin	R*min
P1020F	0,4 m	1,2 m
P2020F	0,4 m	1,2 m
P3020F	0,8 m	1,8 m
P4020F	0,4 m	1,4 m
P5020F	0,4 m	/
P5021F	0,3 m	0,8 m
P6020F	0,4 m	2,0 m
P7010F	0,3 m	/
P7020F	0,3 m	/
P7030F	0,3 m	/
P7040F	0,5 m	/
P7050F	0,5 m	/
P7060F	0,4 m	/
P7070F	0,4 m	/
P8020F	0,5 m	2,0 m
P8030F	0,3 m	1,0 m
P8040F	0,3 m	/
P8050F	0,8 m	1,8 m
P9010F	0,4 m	/
P9020F	0,4 m	/
P9040F	0,4 m	0,9 m
P9050F	0,3 m	1,0 m
P9900F	0,4 m	1,8 m
P9901F	0,4 m	1,8 m

PLINTEN - PLINTHES

	Rmin	R*min
SX105F	0,4 m	/
SX118F	0,4 m	/
SX155F	0,4 m	/



M9010L, M9010A, M9010R
D200, P9010, D300
D503, D504, SX118

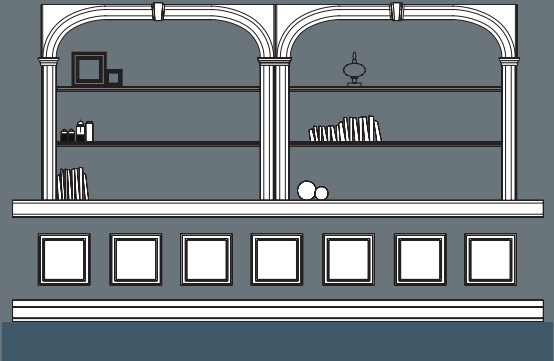

M9010L, M9010A, M9010R, M9010B, M9010C
P9010, P9020
D506, SX105

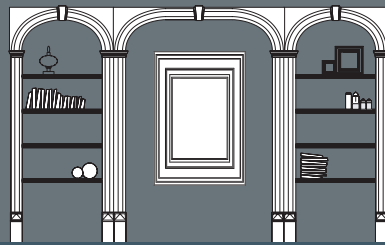

M9010L, M9010A, M9010R, M9010B, M9010C
P9010, D300

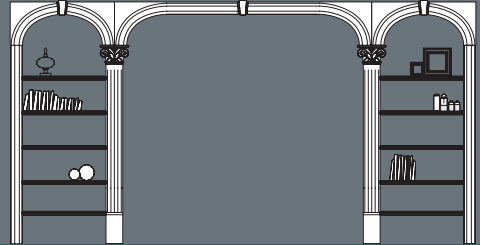

M9010L, M9010A, M9010R
K200, K201, D320
P9010

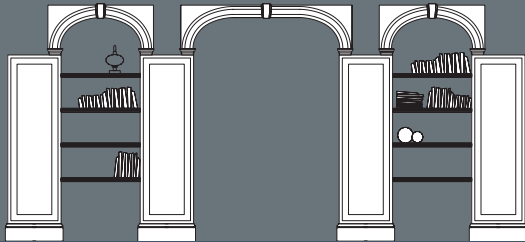

M9010L, M9010A, M9010R, M9010B
P9010
SX105

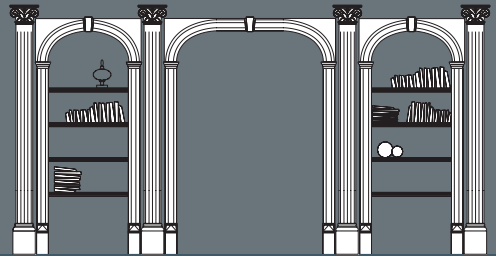

M9010L, M9010A, M9010R, M9010B, M9010C
K201, K200, K202
P9010, D300

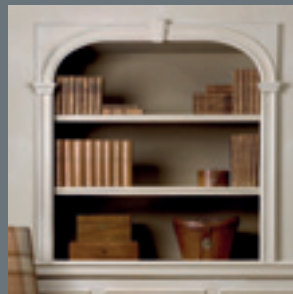

BYBLOS
BYBLOS

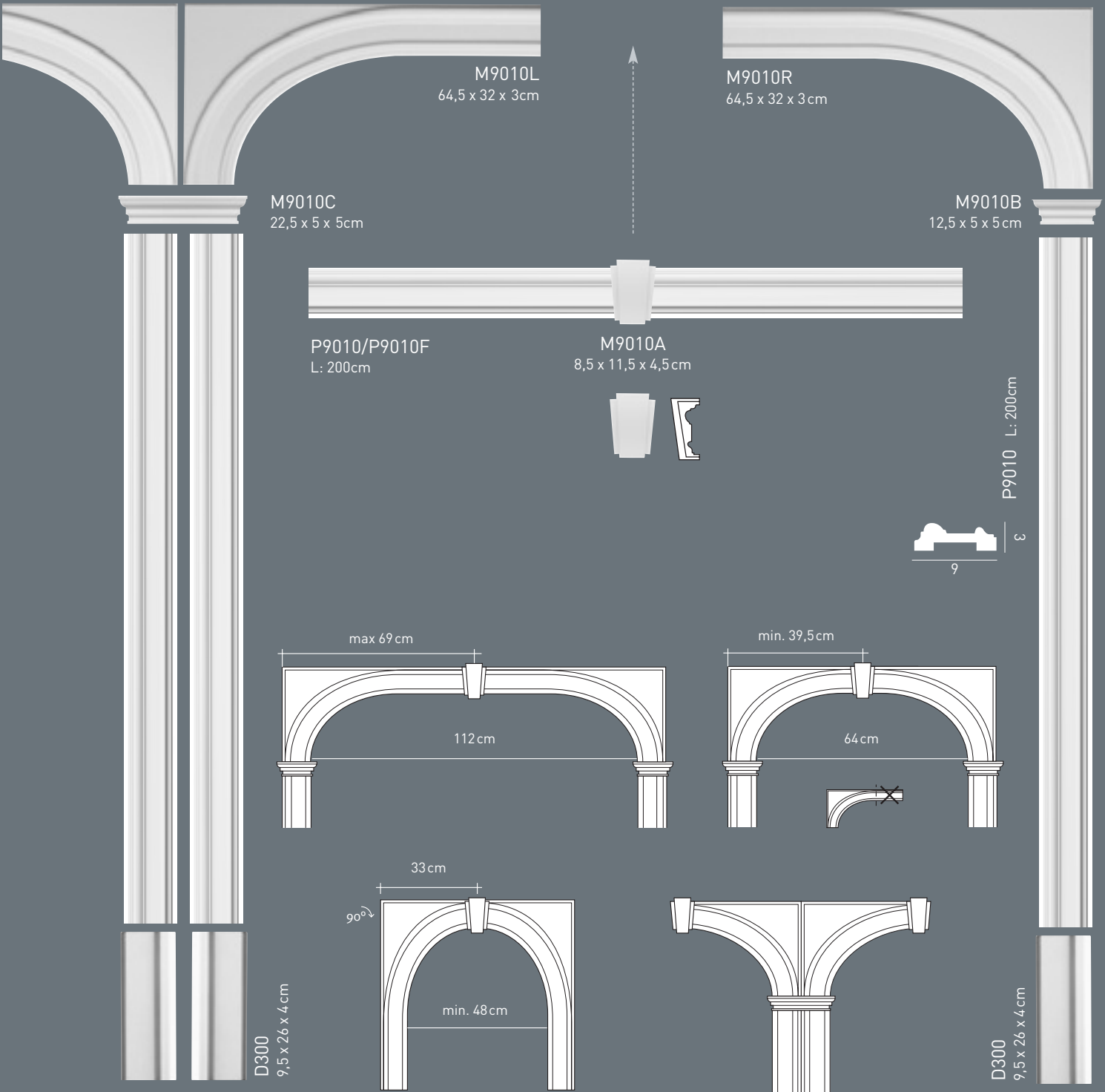

D200
9,5 x 9,5 x 3cm



D210
9,5 x 9,5 x 3,5cm



DX121-2300 L: 230cm



L: 230cm

DX119-2300



L: 230cm

DX121-2300



D310
9,5 x 25 x 3cm



D310
9,5 x 25 x 3cm

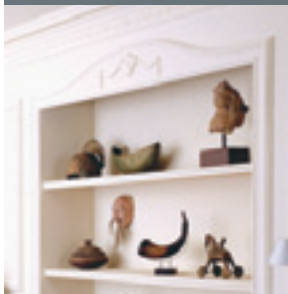

D102, D1014, P9010

D101, D1010, D62, P9010

D101, D1014, P9010

D102, D1014, D62, P9010

DEUROMLIJSTINGEN
ENCADREMENTS DE PORTES

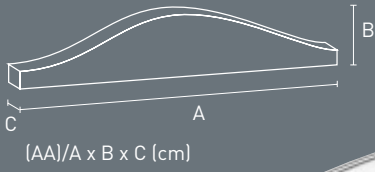

D102
210,5 x 23,5 x 3 cm



D101
125,5 x 19,5 x 3 cm

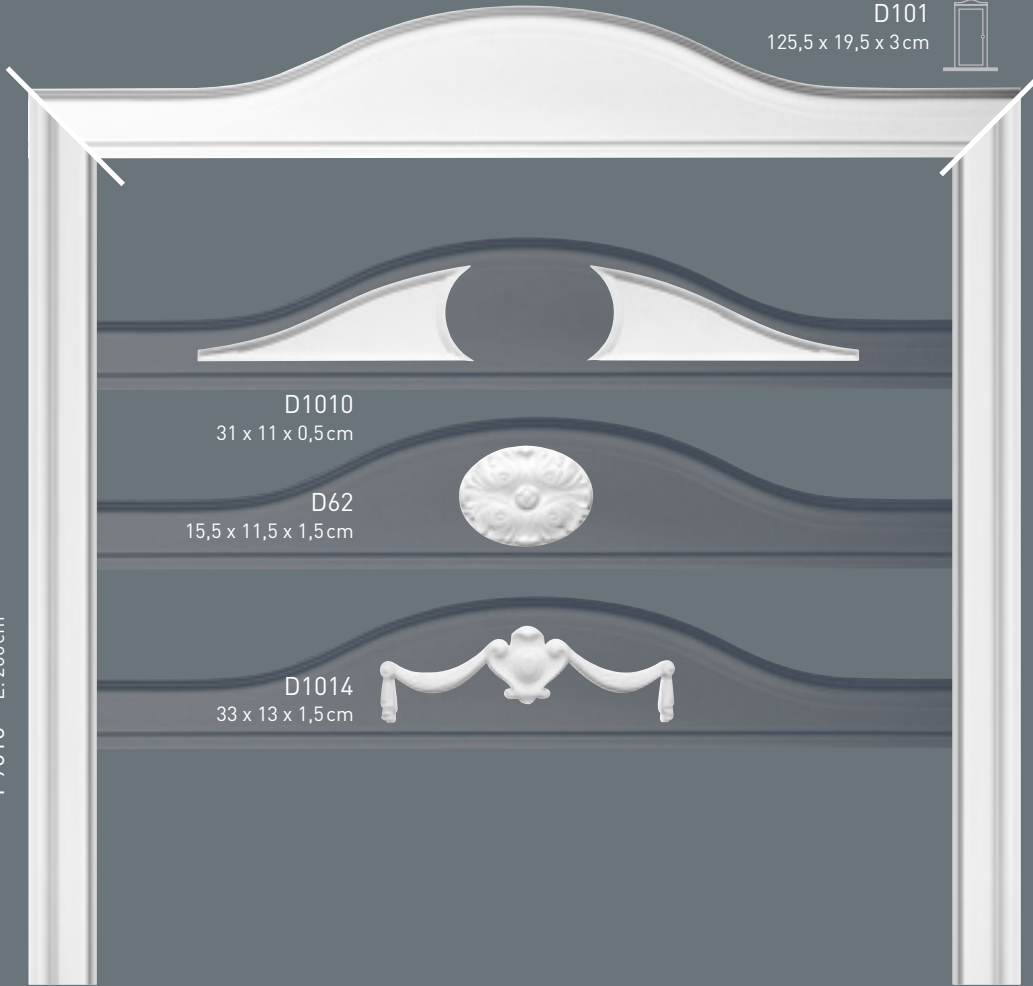



D500 55 x 75 x 1,5cm



D504 55 x 22 x 1,5cm



D507 55 x 90,5 x 1,5cm



F30 60 x 60 x 4cm

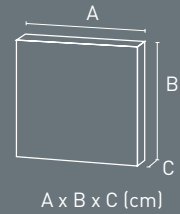

D503 55 x 55 x 1,5cm



D506 43 x 43 x 1,5cm



F31 60 x 60 x 6,5cm



PANELEN
PANNEAUX

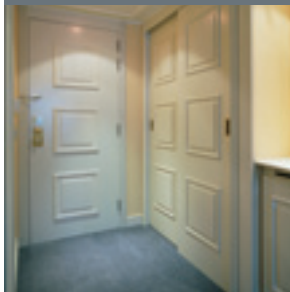

D506

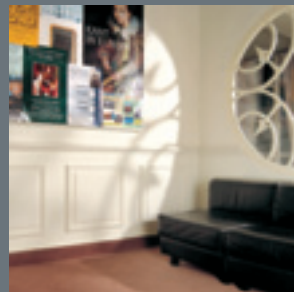

D503

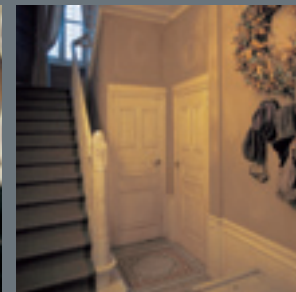

D503, D504



D503

D503, D504

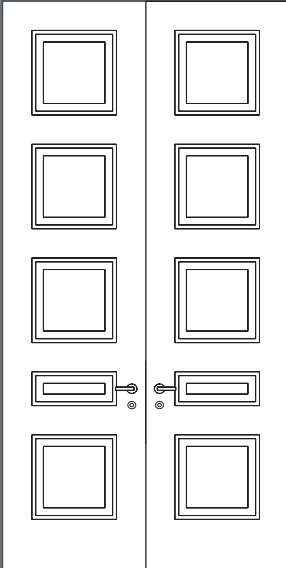

D503, D507, D504

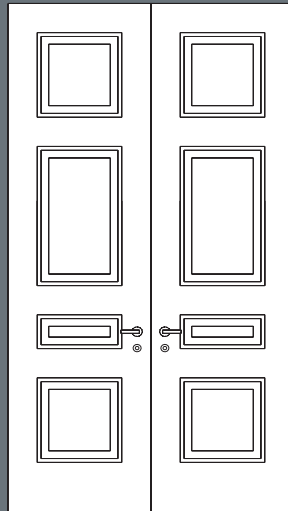

D507, D503, D504

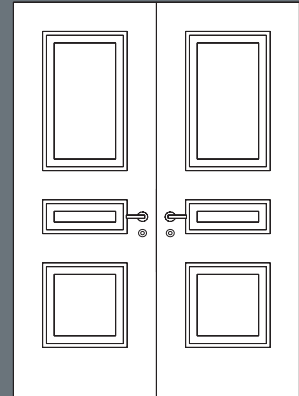

DX119
D503

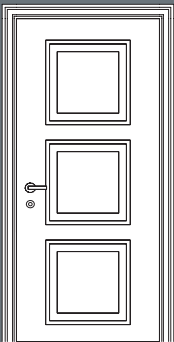

DX119
D500, D504

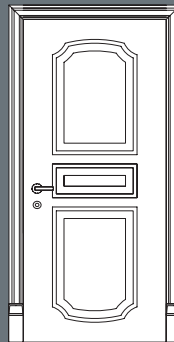

D310

DX 121
D503, D507

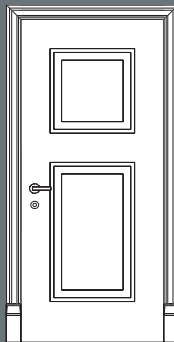

D310

D200, D102
D503, D504

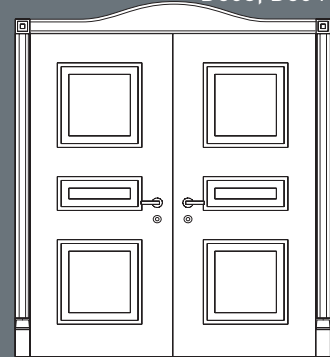

D310

D101, D62, P9020
D504, D507

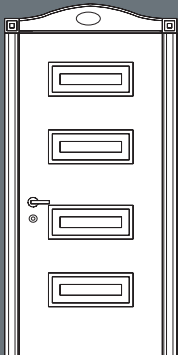

D200, P9010, D310
D504, D503, D507

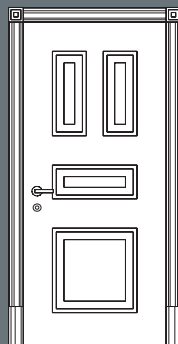

D300

P9010
D504

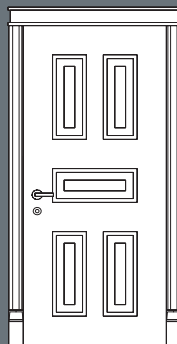

D310

D401, D402, K200
D500, D504, D503

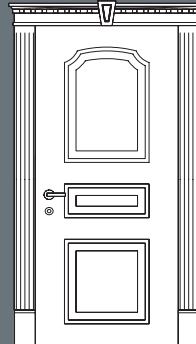

D320

K201L, K200, K201R
D504, D507

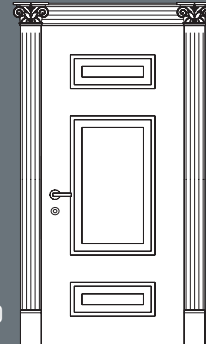

D320

lambrizing
lambris



PANELEN
PANNEAUX

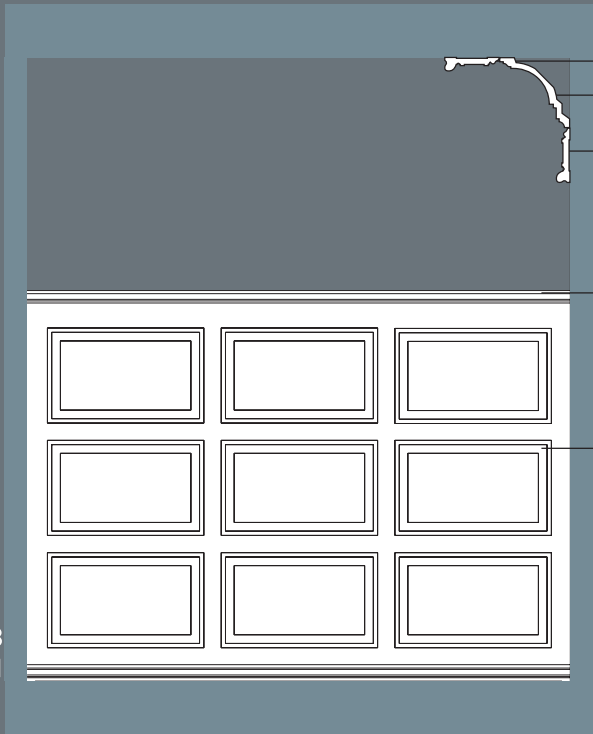
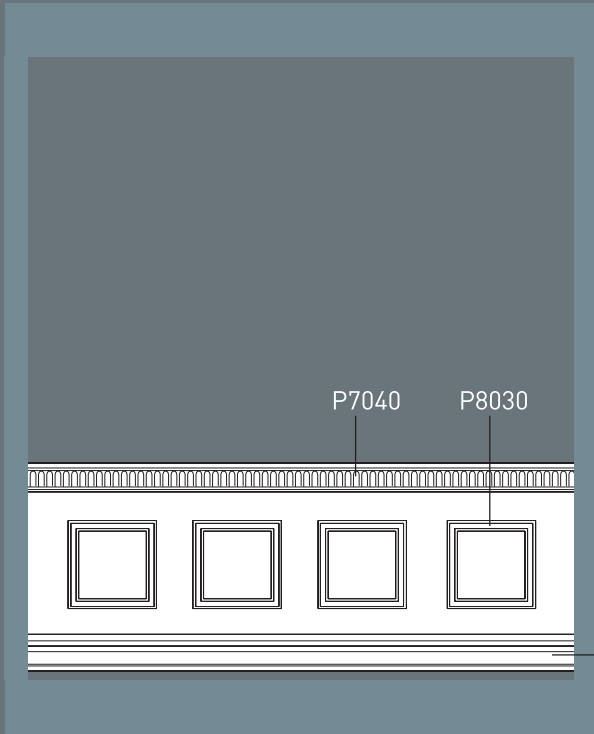
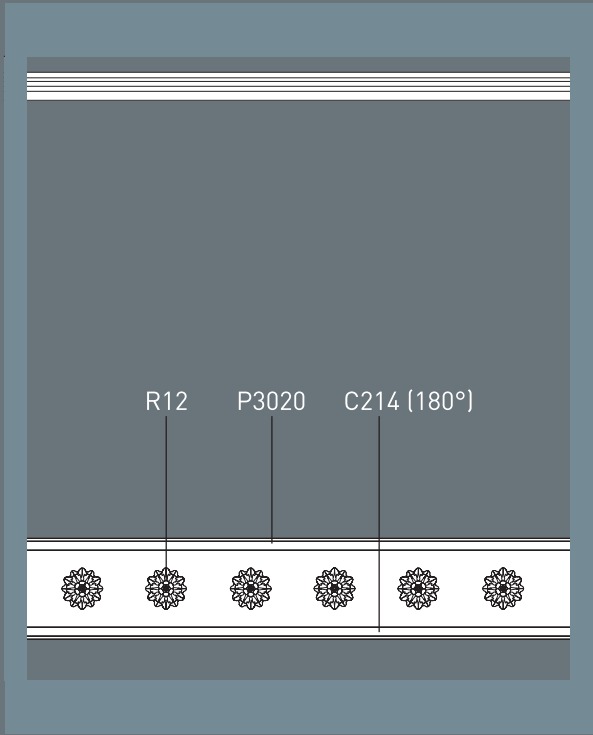
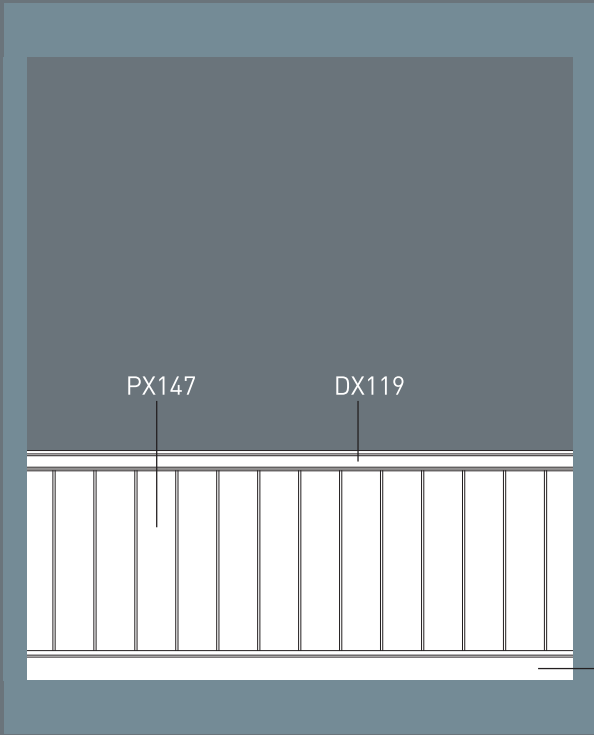

P4020



D120
124/113 x 25 x 9 cm



D400
127,5/122 x 14,5 x 5,5 cm



D401
127,5/122 x 14,5 x 5,5 cm



D400 + D402
127,5/122 x 14,5 x 5,5 cm

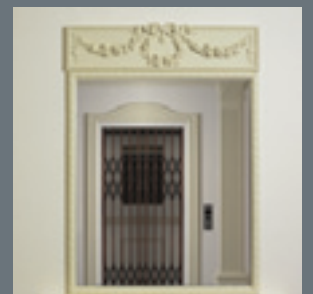
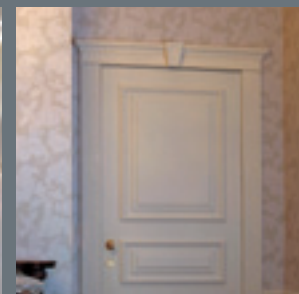
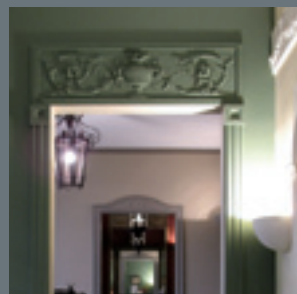

D170

D140, D200, P9020, D101

D401, D402, K200

D161, D101, P2020

FRONTONS
FRONTONS



2 x D401 + D402
max. 245,5/240 x 14,5 x 5,5cm



D402
12/7 x 14,5 x 6 cm
(only for D400 and D401)

K201/L
(H: 15cm)



K201/R
(H: 15cm)



K200

K200 * L: MAX. 200cm



D140
99 x 32 x 2cm



D150
100,5 x 15,5 x 1,5cm



D161
92 x 21,5 x 4cm



D170
105 x 25 x 3,5cm

* K200 zie pg. 121

* K200 voir page 121

glad-geornamenteerd
lisses-à motifs

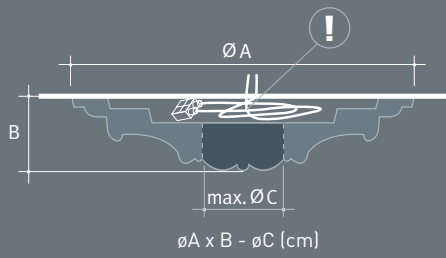

R07
ø26 x 2,5 - ø5 cm



R08
ø38 x 3,5 - ø5 cm



R09
ø48,5 x 4 - ø6 cm



R66
ø54,5/43 x 3,5



R76
ø62 x 4 - ø10,5 cm



R40
ø74,5 x 3,5 - ø10 cm



ROZASSEN
ROSACES

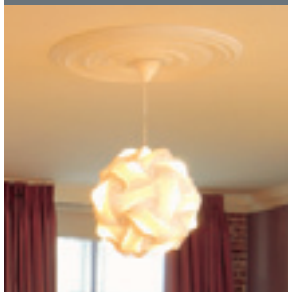

R40



R12



R73

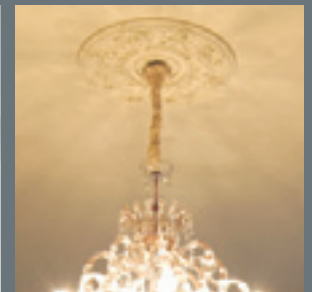

R38



R35
ø22 x 3



R10
ø15 x 4 - ø2cm



R11
ø19 x 4 - ø3cm



R12
ø20 x 2 - ø1cm



R13
ø28,5 x 3,5 - ø2,5cm



R50
ø32 x 4 - ø19cm



R14
ø33,5 x 3 - ø2,5cm



R31
ø38,5 x 3 - ø3,5cm



R61
ø40 x 2,5 - ø2,5cm



R16
ø45 x 4 - ø3cm



R17
ø47 x 3,5 - ø6,5cm



R18
ø49 x 5 - ø7cm



R46
ø53,5 x 4 - ø3cm



R22
(77 x 52,5) x 4cm



R77
ø62 x 4,5 - ø10,5cm

geornamenteerd
à motifs



R74
ø65,5 x 4 - ø8cm



R28
ø68,5 x 3,5 - ø2cm



R52
ø69,5 x 3,5 - ø12,5cm



R73
ø70 x 4 - ø8cm



R38
ø71 x 4,5 - ø19cm



R23
ø71,5 x 4 - ø6cm



ROZASSEN
ROSACES

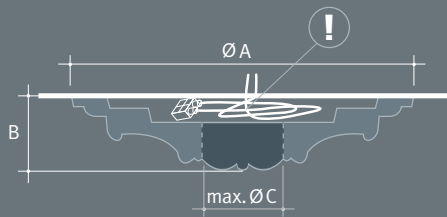

ØA x B - ØC (cm)



R27
 ø75 x 4,5 - ø9 cm

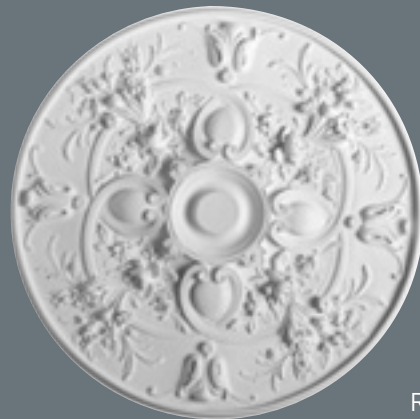

R24
 ø79 x 4 - ø8 cm



R37
 ø85 x 5 - ø7 cm



R64
 ø95,5 x 8 - ø7 cm



plafondtegels - koepels
dalles de plafond-coupoles



F10

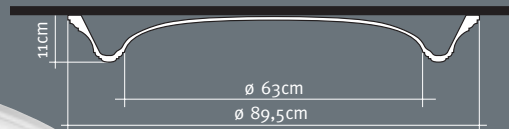

F11

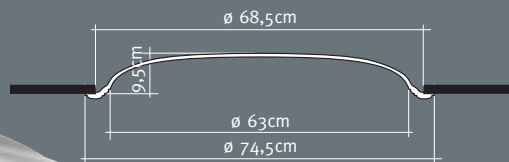

F12

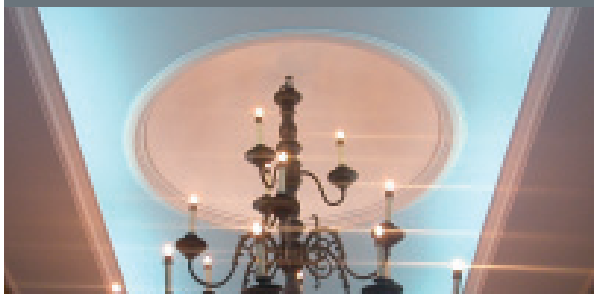
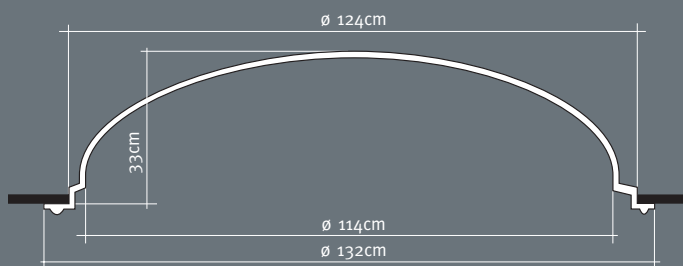

F12

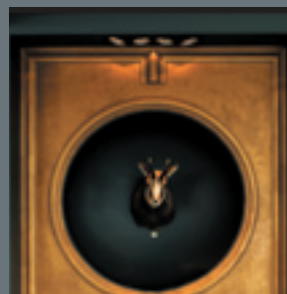

F11

PLAFONDDECORATIE
DÉCORATION DE PLAFONDS

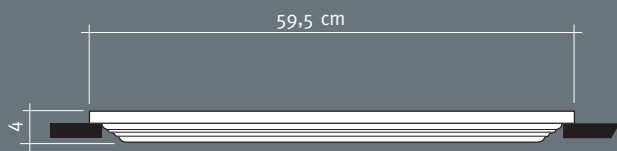

F30
59,5 x 59,5 x 4 cm

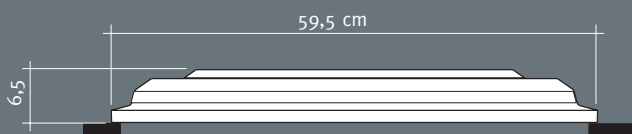

F31
59,5 x 59,5 x 6,5 cm

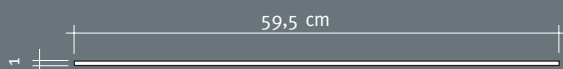

F32
59,5 x 59,5 x 1 cm

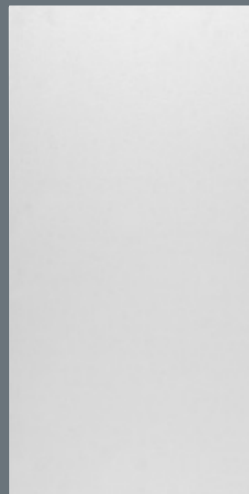
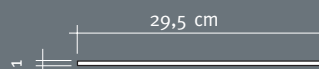

F33
59,5 x 29,5 x 1 cm

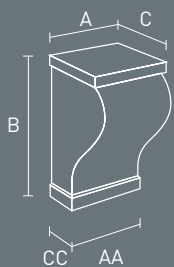

B417
90,5 x 13,5 x 14 cm ↑
75 x 6 cm ↓

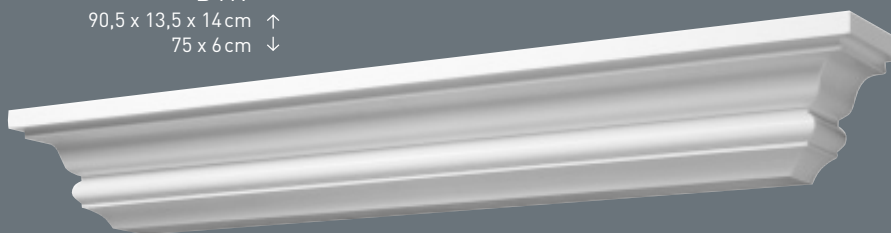

A x B x C (cm)
AA x CC (cm)

B408
22,5 x 40 x 13 cm



B404
19,5 x 31,5 x 11,5 cm



B403
19 x 19 x 10 cm



B402
9 x 22 x 7 cm



B401
11,5 x 15,5 x 7 cm



B409
30 x 35 x 17,5 cm



B413
16 x 22,5 x 8,5 cm



B414
10 x 22 x 7 cm



B410
19,5 x 50 x 16 cm

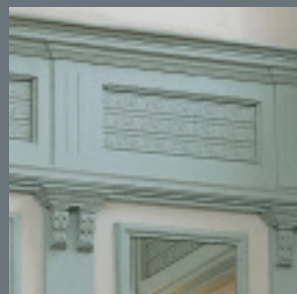
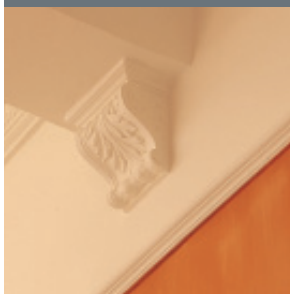

B408

B401

B410

SCHAPPEN & CONSOLES
ÉTAGÈRES ET CONSOLES

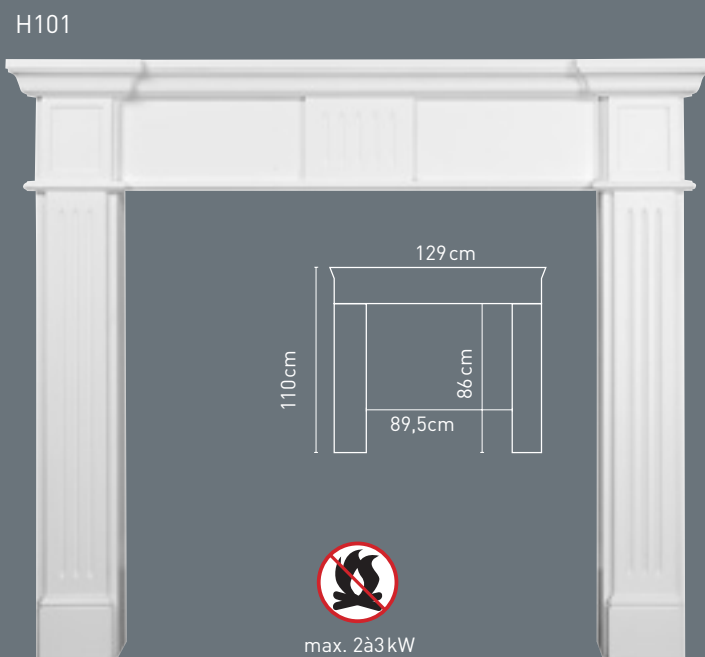
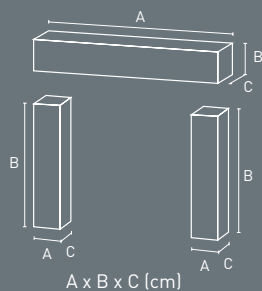
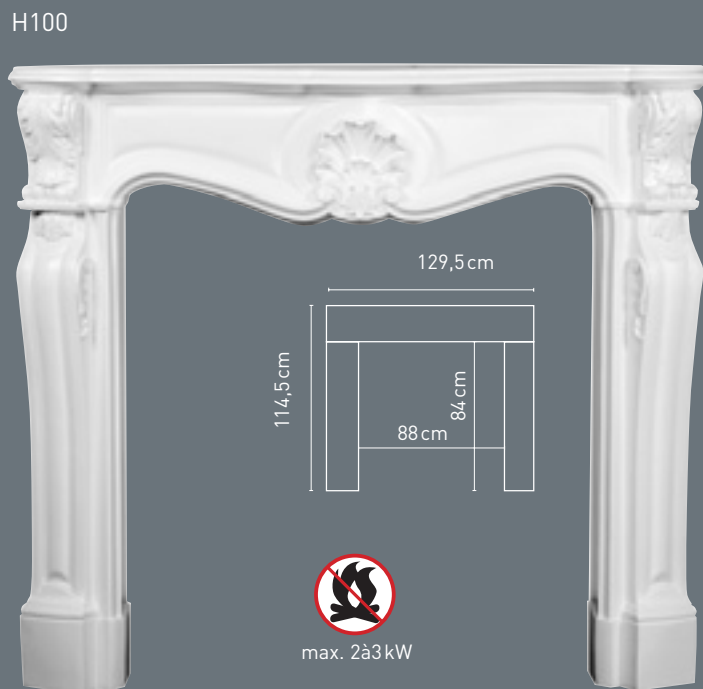

SIERSCHOUWEN
CHEMINÉES DÉCORATIVES

De sierschouwen zijn **enkel als decoratief element bedoeld** en mogen uitsluitend geplaatst worden in combinatie met een elektrisch vuurtje van max. 2 à 3kW.

Les cheminées sont **des éléments décoratifs**. Elles peuvent seulement être employées avec un feu électrique de max. 2 à 3kW.

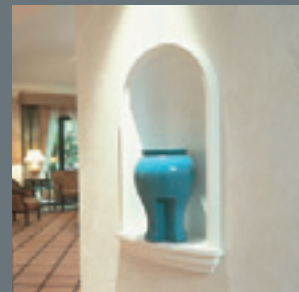

G50,G51

N503 + N520

N503 + N520

N503 + N510

NISSEN - SIERELEMENTEN
NICHES - ÉLÉMENTS DÉCORATIFS

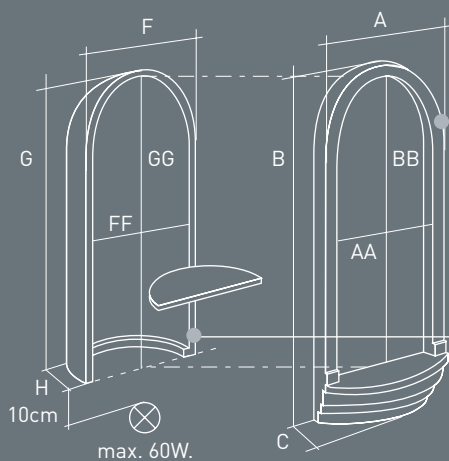

(cm)	A	B	C	AA	BB
N403	43,0	70,5	10,0	26,5	55,0
N404	42,0	76,0	11,0	24,5	55,0
N503	69,0	112,5	11,0	51,5	94,5
N504	69,0	113,0	11,0	49,5	94,5
(cm)	F	G	H	FF	GG
N410	31,0	59,5	9,5	28,0	58,5
N510	55,0	98,5	18,0	53,0	96,0
N520	55,0	97,5	18,0	53,0	92,0

Plaats de gloeilamp (max. 60W) op min. 10cm afstand van de opale bodem.

Installez l'ampoule (max. 60W) à 10cm minimum du fond opaque.

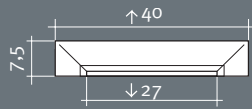

K241
(H: 16,5 cm)

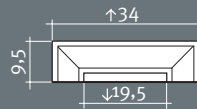

K221
(H: 22 cm)

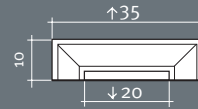

K223
(H: 22,5 cm)

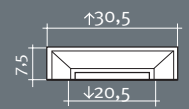

K224
(H: 17 cm)

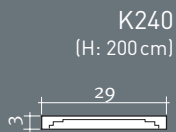

K240
(H: 200 cm)

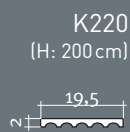

K220
(H: 200 cm)



K220
(H: 200 cm)



K220
(H: 200 cm)

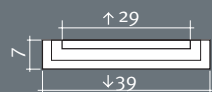

K254
(H: 53 cm)

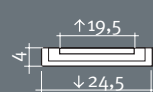

K255
(H: 54 cm)

K255
(H: 54 cm)

K255
(H: 54 cm)



PILASTERS
PILASTRES

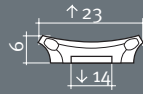
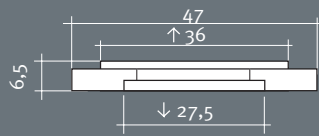
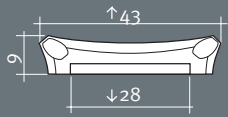

K251
(H: 35,5 cm)

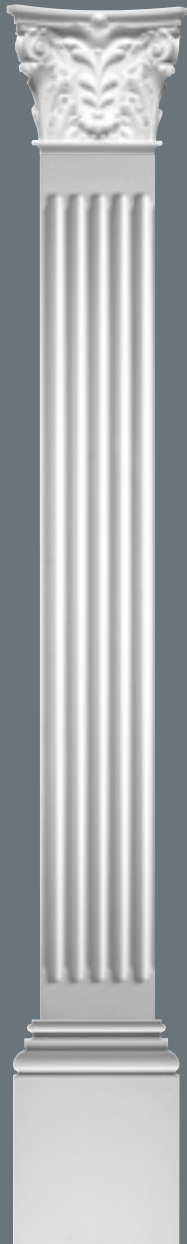

K253
(H: 13,5 cm)

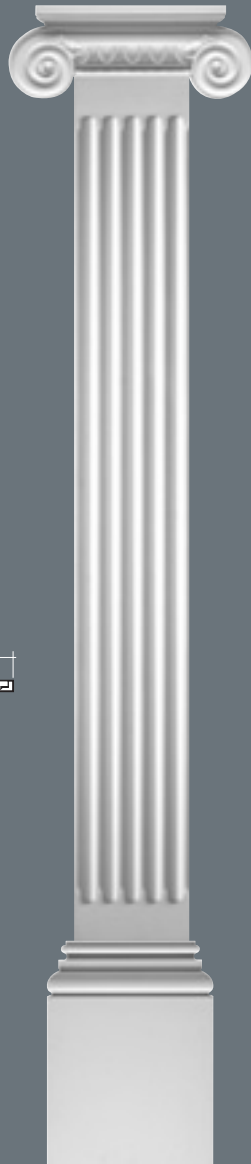

K201
(H: 15 cm)



K250
(H: 200 cm)

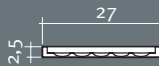

K200
(H: 200 cm)



K200
(H: 200 cm)



K254
(H: 53 cm)

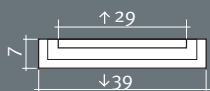

K202
(H: 54 cm)

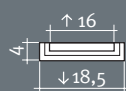

D320
(H: 25 cm)



volle zuilen
colonnes entières

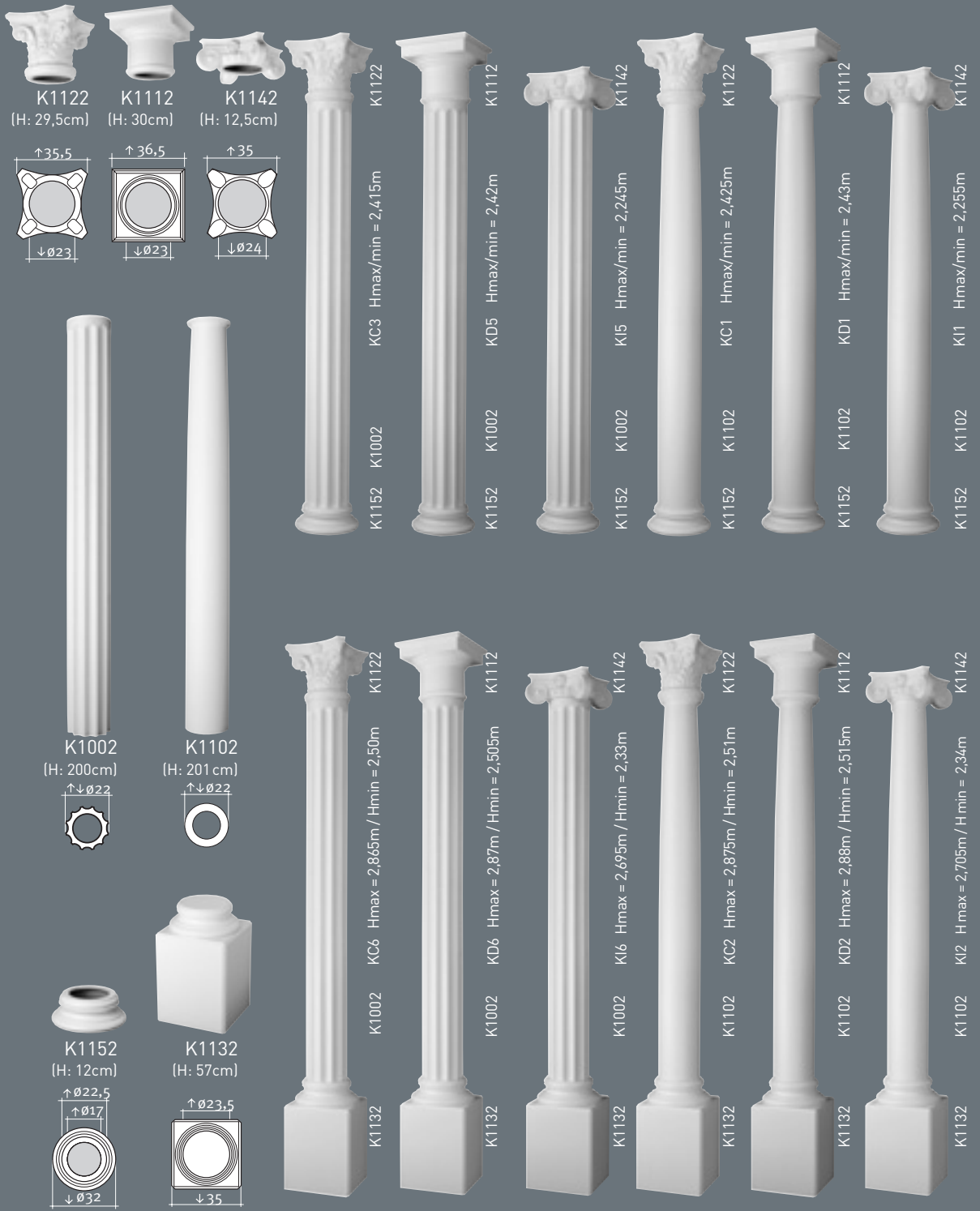



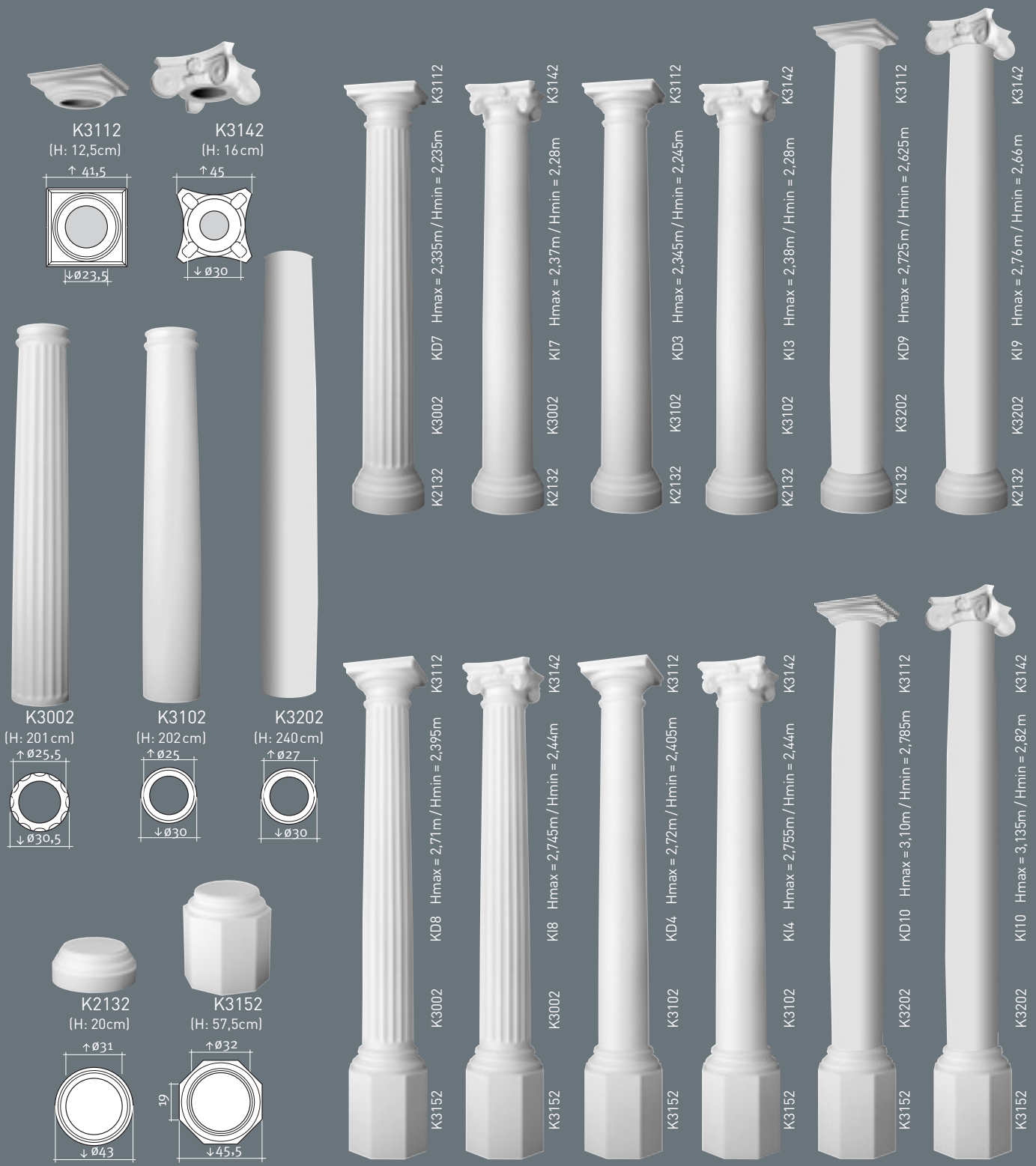













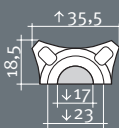
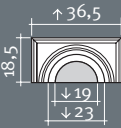
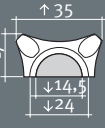

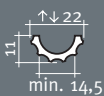
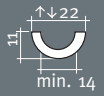
ZUILEN
COLONNES

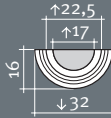
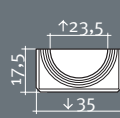

halve zuilen demi-colonnes



 K1121 (H: 29,5cm)	 K1111 (H: 30cm)	 K1141 (H: 12,5cm)	 K1121	 K1111	 K1141	 K1121	 K1111	 K1141
 ↑ 35,5 ↓ 17 ↓ 23	 ↑ 36,5 ↓ 19 ↓ 23	 ↑ 35 ↓ 14,5 ↓ 24	K1151 K1001 KC3H Hmax/min = 2,415m	K1151 K1001 KD5H Hmax/min = 2,42m	K1151 K1001 KI5H Hmax/min = 2,245m	K1151 K1101 KC1H Hmax/min = 2,425m	K1151 K1101 KD1H Hmax/min = 2,43m	K1151 K1101 KI1H Hmax/min = 2,255m
 K1001 (H: 200cm)	 K1101 (H: 201 cm)							
 ↑ 22 min. 14,5	 ↑ 22 min. 14							
 K1151 (H: 12cm)	 K1131 (H: 57cm)							
 ↑ 22,5 ↑ 17 ↓ 32	 ↑ 23,5 ↓ 35							
 K1131	 K1131	 K1141	 K1121	 K1111	 K1141	K1001 K1001 KC6H Hmax = 2,865m / Hmin = 2,50m	K1001 K1001 KD6H Hmax = 2,87m / Hmin = 2,505m	K1001 K1001 KI6H Hmax = 2,695m / Hmin = 2,33m
K1101 K1101 KC2H Hmax = 2,875m / Hmin = 2,51m	K1101 K1101 KD2H Hmax = 2,88m / Hmin = 2,515m	K1101 K1101 KI2H Hmax = 2,705m / Hmin = 2,34m						

ZUILEN
COLONNES

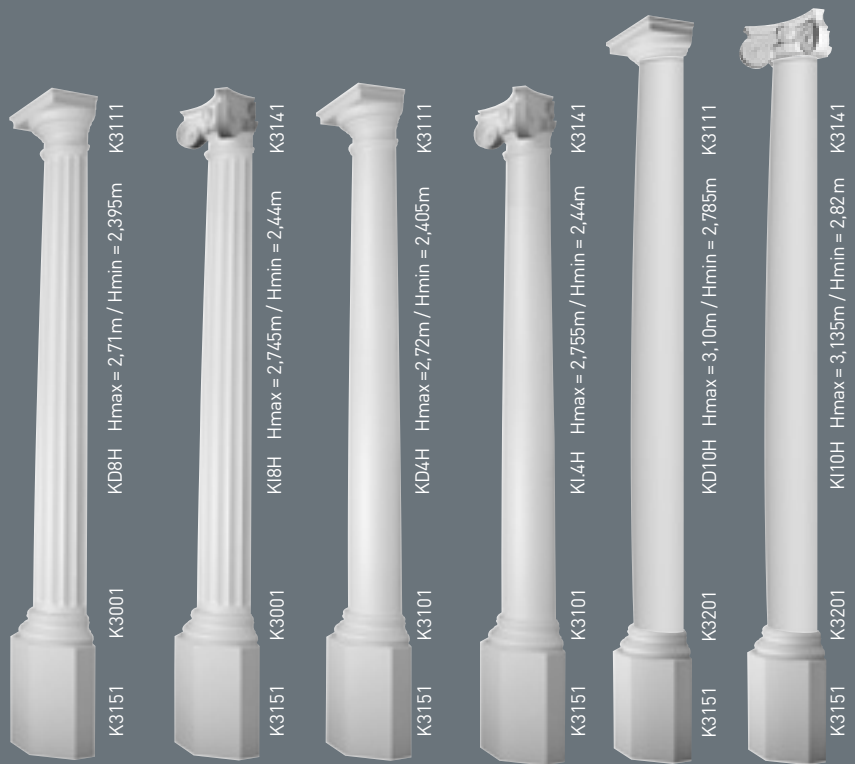
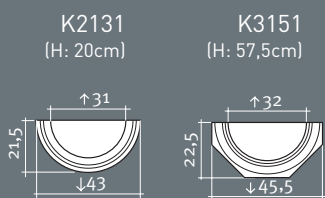
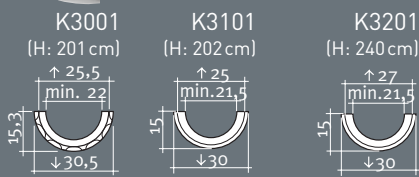
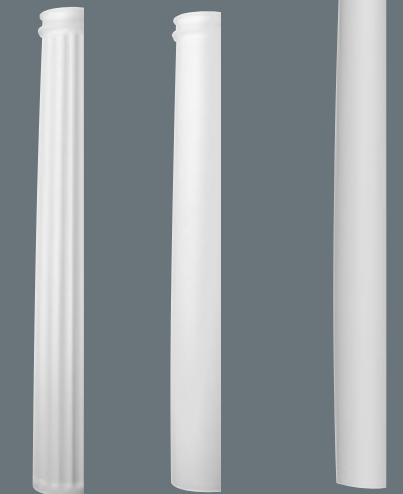
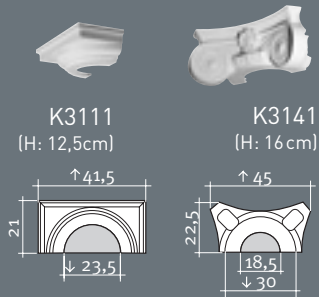

XL-gesegmenteerde zuil
 XL-colonne segmentée

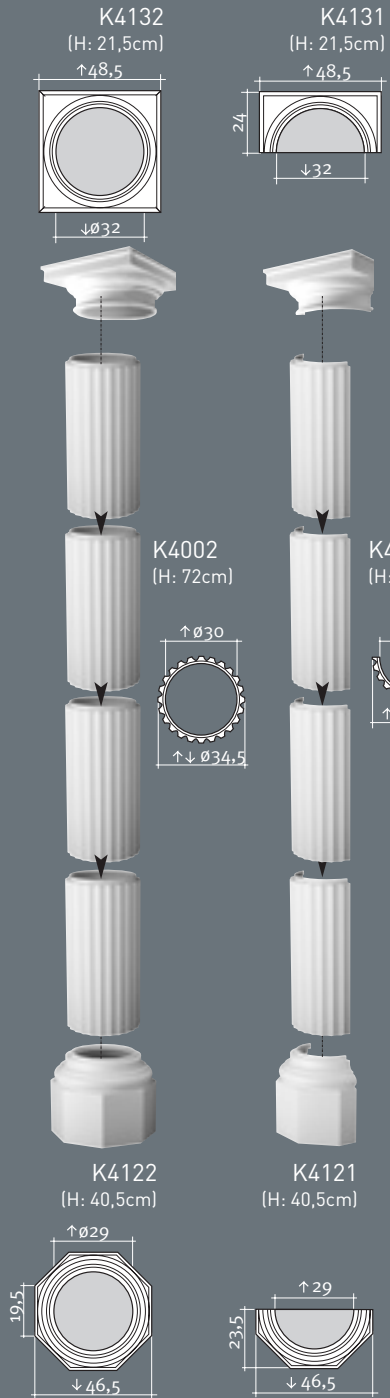

5 x K4002
 + K4132 + K4122
 = 4,09 m

4 x K4002
 + K4132 + K4122
 = 3,39 m

3 x K4002
 + K4132 + K4122
 = 2,69 m

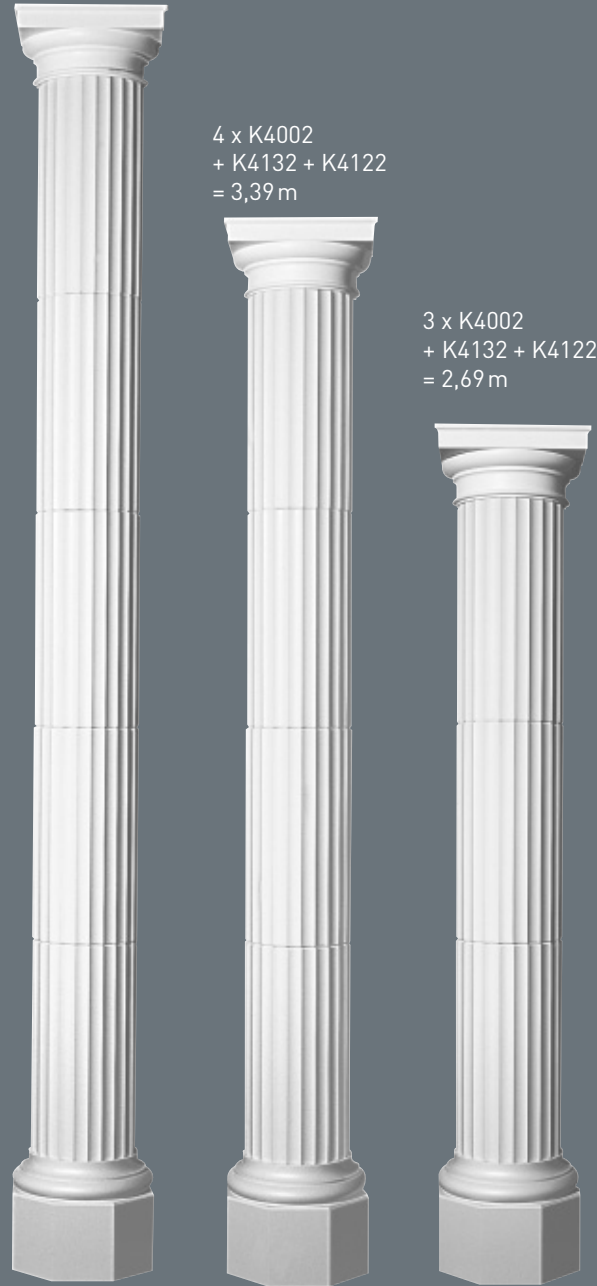

ZUILEN
 COLONNES

wandlampen
appliques

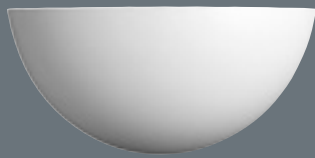

L504
30,5 x 15 x 15cm



L505
41 x 11,5 x 16,5cm

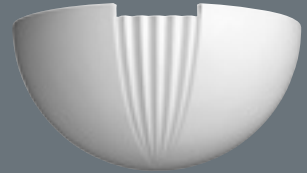

L509
29 x 17 x 14,5cm



L512
30,5 x 12,5 x 15,5cm

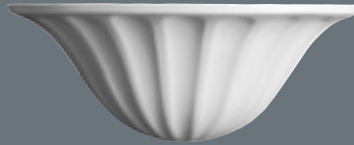

L506
39 x 15,5 x 19cm



L501
35 x 22 x 16cm



max. 60W/230V
E27



max. 15W/230V
E27



max. 60W/230V
E27

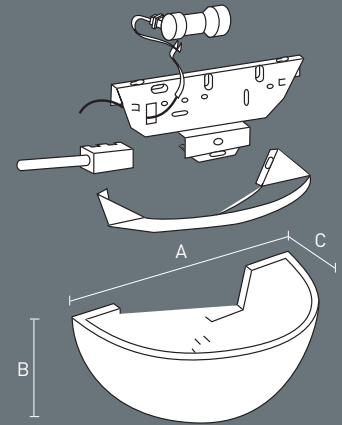

A x B x C (cm)



L506

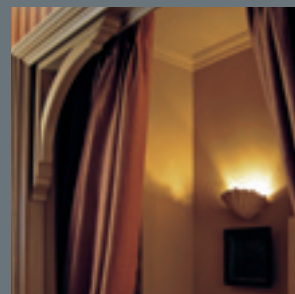

L501

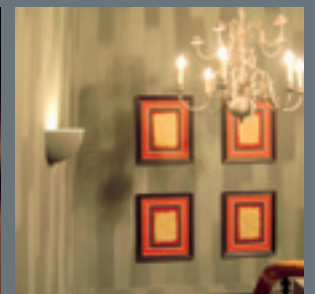

L504

VERLICHTING
ÉCLAIRAGE

kroonlijsten voor inditecte verlichting
corniches d'éclairage indirect

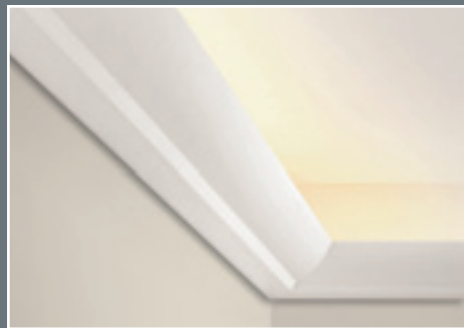

C351

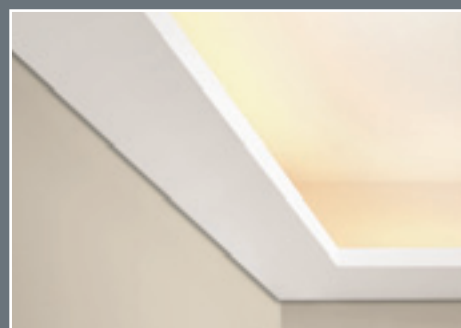
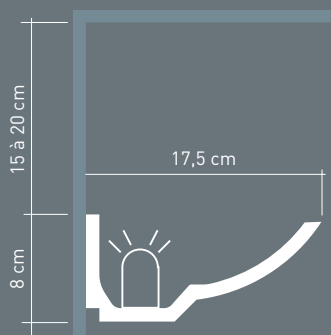

C352

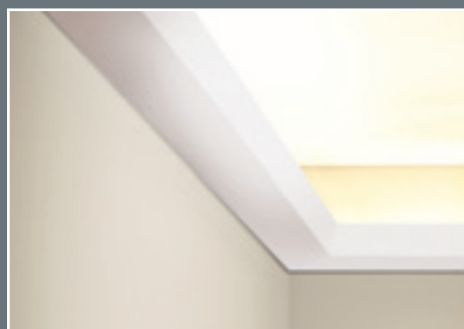
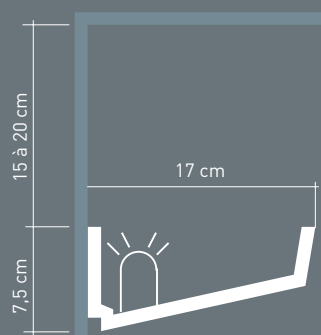

C357

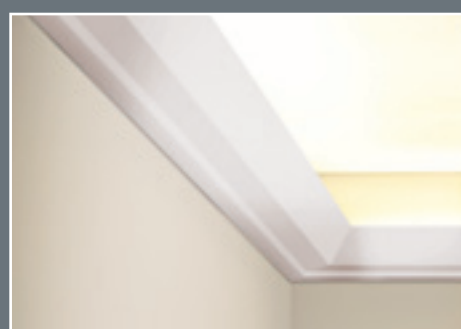
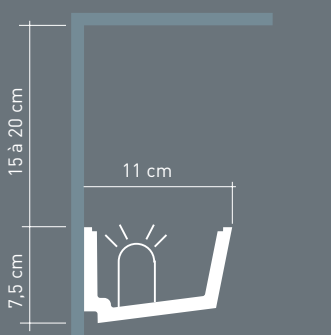

C358

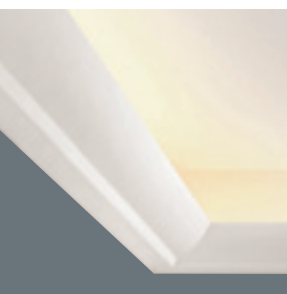
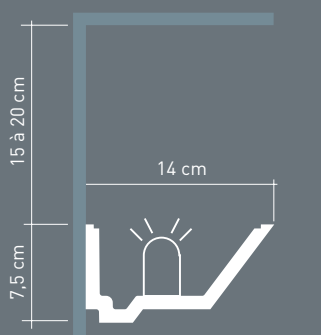

VERLICHTING
ÉCLAIRAGE

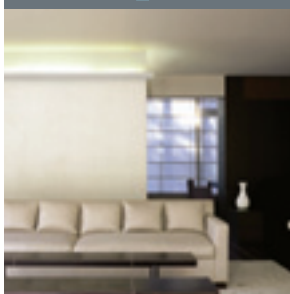

C357

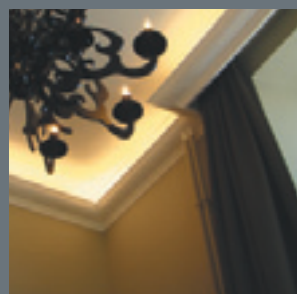

C900

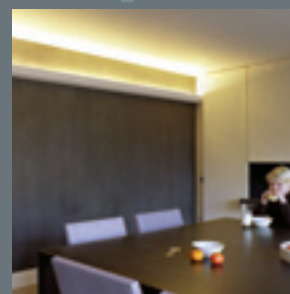

C358



C356, C351

DESIGNED BY: J. VERGRACHT: C351, C352, C357, C358

© REGISTERED DESIGN: C351, C352



C902

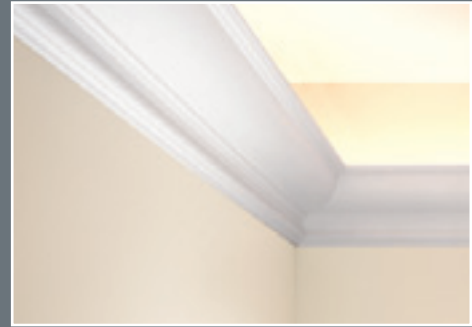
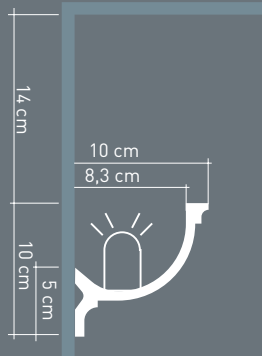

C901

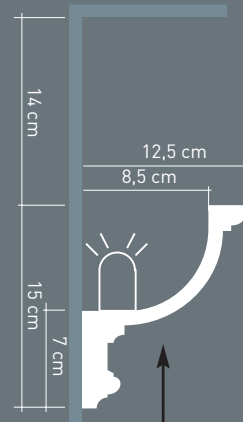

C900

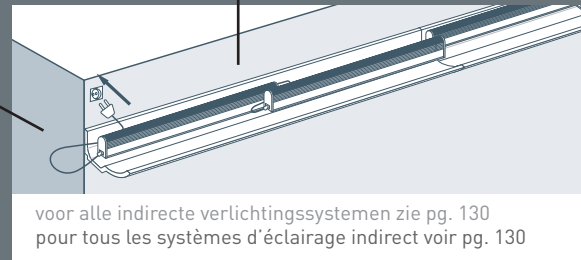
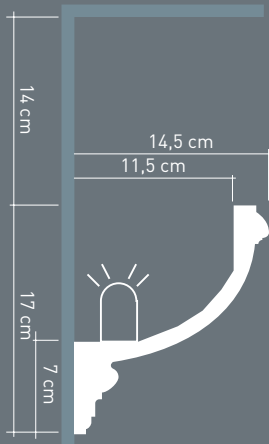

voor alle indirecte verlichtingssystemen zie pg. 130
 pour tous les systèmes d'éclairage indirect voir pg. 130



LIGHTING STRING



IL100

Flexibele armatuur, incl. 14 lamphouders
 Armature flexible, 14 douilles incl.

L: 200 cm



IL110

15 lampjes/lampes Vacuüm 10W-12V



IL120

transformator 150W-12V
 1 transfo 150W per lengte van 2m

transformateur 150W-12V
 1 transfo 150W par longueur de 2m

PLEXI COVERS



IL000-001

5 x plexi cover voor C357, L: 100 cm
 5 x couvertures en plexi pour C357, L: 100 cm

IL000-002

5 x plexi cover voor C358, L: 100 cm
 5 x couvertures en plexi pour C358, L: 100 cm

T5 TUBE



IL002-002



IL002-002

L: 119cm

T5 HE 1x 28W incl.

incl. connectiekabel/câble de connection incl. L: 50 cm



IL002-001

IL002-001

L: 59 cm

T5 HE 1 x 14W incl.

incl. connectiekabel/câble de connection incl. L: 50 cm



IL002-003

L: 180cm

stroomkabel/fil électrique

max. 12 lengtes per stroomkabel

max. 12 armatures par fil électrique

LIGHT PLATE



IL001-006



IL001-006

L: 200 cm (max 223cm)

T5 HE 2 x 28W excl.

Philips DALI Touch & Dim

Digitale dimmer incl./Variateur de lumière digitale incl.



IL001-005

IL001-005

L: 50 cm (max 55cm)

T5 HE 1 x 14W excl.

Philips DALI Touch & Dim

Digitale dimmer incl./Variateur de lumière digitale incl.

max. 30 armaturen in één lijn/max. 30 armatures en ligne

LED INSERT



Ø4 cm x 9 mm



IL003-001

set van 5 LEDS (1W)
+ verlengkabels (5x 1m, 2m, 3m)
+ transformator max. 5 LEDS
Het is mogelijk 1 LED lamp te vervangen

Set de 5 LEDS (1W)
+ câbles d'extension (5x 1m, 2m, 3m)
+ converteur de puissance max. 5 LEDS
Possibilité de changer une lampe LED



IL003-002

transformator max. 40 lampjes
converteur de puissance max. 40 lampes

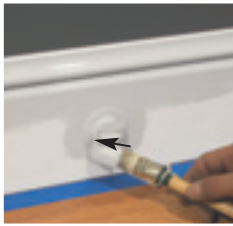
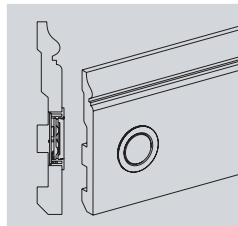

Gebruik IL003 bijvoorbeeld in / veuillez utiliser par exemple IL003 avec:
C220, C305, C400, C354, P5050, P5051, SX104, SX105, SX118, SX137, SX138, TF06, ...

IL003
(+ SX118)



VERLICHTING
ÉCLAIRAGE

Alle technische informatie vindt u terug op www.oracdecor.com.
Gedetailleerde installatieinstructies in de verpakking.

Vous trouverez toutes les informations techniques sur www.oracdecor.com.
Des instructions d'installation détaillées incluses dans l'emballage.



L600-001

19,5 x 34 x 8,5 cm

inbouwarmatuur voor spaarlamp (18W - G24 - q2)

luminaire encastrée pour lampe économique (18W - G24 - q2)

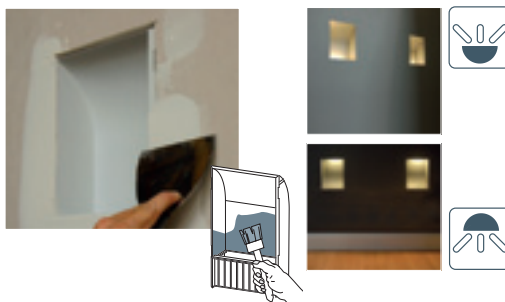

L601-001

10 x 9 x 10 cm

inbouwarmatuur voor MycroLynx F7W (wit & kleur)
of MycroLynx LED (wit & kleur)

luminaire encastrée pour MycroLynx F7W (en blanc et en couleur)
ou MycroLynx LED (en blanc et en couleur)



Lampjes worden niet door ORAC verkocht.
Les ampoules ne sont pas fournies par ORAC.

technische informatie
informations techniques



TECHNISCHE INFO
INFOS TECHNIQUES

toeboren
accessoires

FB13

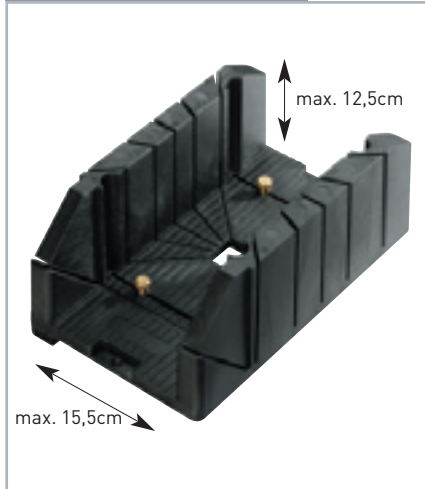

FB14



FB300

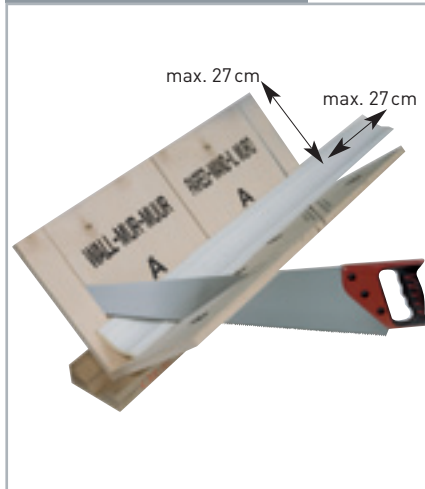

FDP100



FB10 Variomatic

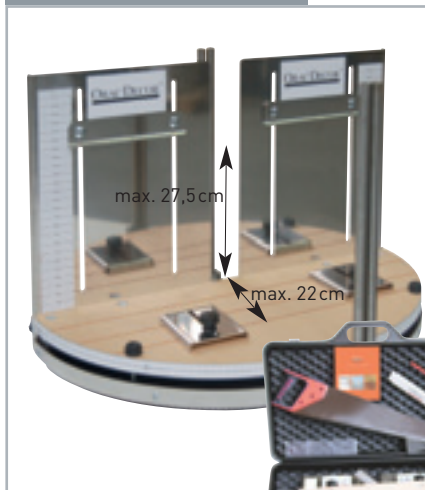

FB15



TECHNISCHE INFO
INFOS TECHNIQUES

FDP500	310 ml	7 à 8 m
FDP600	2700 ml	± 48 m



DecoFix Pro

EXTRA STERKE installatielijm

Traagdrogende extra sterke lijm die een duurzame verbinding creëert tussen de lijsten en de wand en/of het plafond. Geschikt voor Orac Luxxus, Orac Axxent en Orac Basixx profielen op poreuze ondergrond en voor binnentoepassingen.

Colle pour fixer les moulures ULTRA FORTE

Colle d'adhésion ultra forte à séchage lent qui garantit une adhésion durable entre les corniches/cimaises et le mur et/ou le plafond. Appropriée pour Orac Luxxus, Orac Axxent et Orac Basixx sur des surfaces poreuses et pour des applications à l'intérieur.

FDP700	290 ml	7 à 8 m
--------	--------	---------



DecoFix Hydro

EXTRA STERKE installatielijm voor BUITEN

Extra sterke installatielijm voor gebruik in vochtige ruimtes, voor buitentoepassingen en op niet-poreuze ondergrond ter vervanging van DecoFix Pro.

Colle pour fixer les moulures ULTRA FORTE pour l'EXTÉRIEUR

Colle d'adhésion ultra forte pour des applications à l'extérieur, dans des endroits humides et sur des surfaces non-poreuses au lieu du DecoFix Pro.

FX200	310 ml	min. 80m
FX210	80 ml	min. 20m



DecoFix Extra

Lijm voor perfecte naadverbindingen

Lijm voor naadverbindingen tussen lijsten onderling. Na aanbrengen van lijm de profielen goed tegen elkaar aanduwen en overtollige DecoFix Extra bij voorkeur vóór uitharding (vanaf een paar uur) verwijderen met aceton of Synth Thinner. De lijm overschilderen na 24 uur.

Colle pour un assemblage parfait des joints

Une colle pour souder les cimaises entre-elles. Poussez fortement les profils l'un contre l'autre et éliminez l'excédent de colle DecoFix Extra de préférence avant durcissement (attendre au moins deux heures) avec de l'acétone ou du Synth Thinner. Peindre la colle après 24 heures.

BINNENINSTALLATIE HARDE KROONLIJSTEN INSTALLATION DE CORNICHES DURES DANS UN INTÉRIEUR

Garantievoorwaarden gelden enkel bij volledige naleving van de installatieinstructies.

Les conditions de garantie sont uniquement valables en cas d'observation complète des instructions de pose.

voor perfecte installatie:
pour une installation parfaite:



installatie
installation

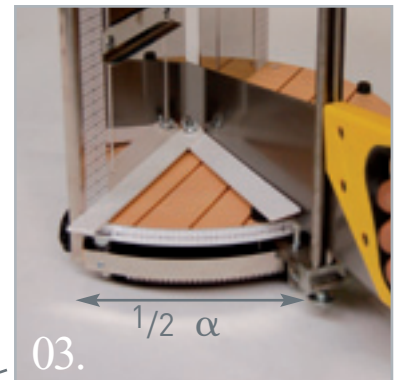
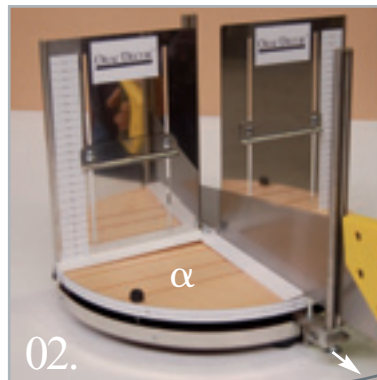
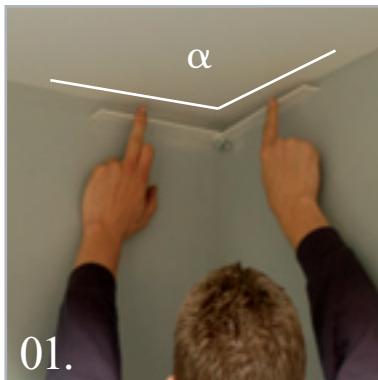

TECHNISCHE INFO
INFOS TECHNIQUES

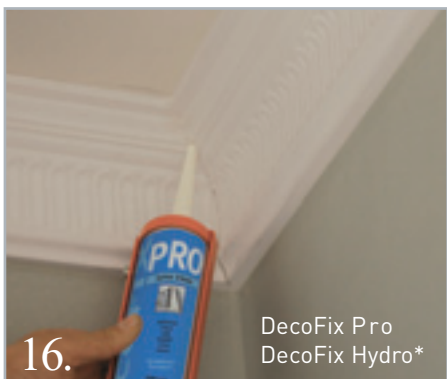

* voor buitentoepassingen en in vochtige ruimtes.

* pour toutes applications à l'extérieur ou dans les endroits humides.

BUITENTOEPASSINGEN APPLICATIONS EXTÉRIEURES

Zowel de Orac Luxxus als de Orac Axxent producten zijn geschikt voor buiten en in vochtige ruimtes. Voor de verlijming gaat u hetzelfde te werk als bij binnentoepassingen, maar u vervangt de DecoFix Pro door de DecoFix Hydro.

Deze producten dienen met een kwalitatieve buitenverf overschilderd te worden.

Tant les produits Orac Luxxus que les produits Orac Axxent conviennent pour l'extérieur et les endroits humides.

Pour encoller ces produits, vous procédez de la même façon que pour les applications à l'intérieur, mais vous remplacez la DecoFix Pro par la DecoFix Hydro.

Ces produits doivent être parachevés avec une peinture spéciale pour extérieur.

GARANTIE & BRANDVOORSCHRIFTEN GARANTIE & NORMES ANTI-INCENDIE

ORAC DECOR® ornamenten zijn onbreekbaar, licht en gemakkelijk te installeren. Ze worden verwerkt als licht hout en afgewerkt met kwaliteitsverven.

Alle technische informatie vindt u terug op www.oracdecor.com.

Garantievoorwaarden gelden enkel bij volledige naleving van deze instructies.

Controleer de afmetingen van de ornamenten op de werkplaats vooraleer te installeren. Maatwijzigingen en afwijkingen ten opzichte van deze catalogus voorbehouden.

Contacteer ons gerust voor verdere inlichtingen.

BRANDVOORSCHRIFTEN

In veel interieurs of projecten zijn strikte brandvoorschriften opgelegd. Orac heeft daarvoor verschillende oplossingen, afhankelijk van het land en zijn reglementeringen. Contacteer ons 'engineering department' voor een specifiek verzoek.

Les ornements ORAC DECOR® sont incassables, légers et faciles à installer. Ils sont utilisés comme du bois léger et parachevés avec des peintures de qualité.

Vous trouverez toutes les informations techniques sur www.oracdecor.com.

Les conditions de garantie ne sont d'application que si ces instructions ont été suivies à la lettre.

Contrôlez les dimensions des ornements dans la pièce où ils doivent être installés, avant de procéder à l'installation, sous réserve de modifications et de discordances avec les mesures indiquées dans ce catalogue.

N'hésitez pas à nous contacter pour obtenir de plus amples informations.

NORMES ANTI-INCENDIE

Pour beaucoup d'intérieurs et de projets, les exigences en terme de prévention incendie sont très strictes. C'est pour cette raison qu'Orac propose quelques produits répondant aux standards anti-feu et élabore des solutions adaptées aux exigences de votre projet. Contactez nous pour plus d'information.



TECHNISCHE INFO
INFOS TECHNIQUES

VERKLARING SYMBOLEN EXPLICATION DES SYMBOLES

© REGISTERED MODELS:

C351: 000257464-0003
C352: 000257464-0004
C353: 000257464-0005
C354: 000257464-0006
C355: 000257464-0007
C356: 000257464-0008

C335: 000995576-0001
C336: 001035273-0001
C990: 000995576-0002

P5051: 000257464-0001
P5050: 000257464-0002

P8050: 000995576-0003
P9900: 000995576-0004
P9901: 000995576-0005

SX156: 000995576-0006



Klasse I met aarding
Classe I avec terre



Klasse II met dubbele isolatie
Classe II avec double isolation



Klasse 3 laagspanning
Classe 3 basse tension



Geschikt voor directe bevestiging in/op
normaal ontvlambare oppervlakten
Convient pour un montage direct
dans/sur des surfaces inflammables



12V 12V gelijkspanning
12V tension continue



230V
240V
50Hz 230 - 240 Volt
230 - 240 Volt



Beschermingsindicatie
Indice de protection



CE norm
CE Norme



GS-gekeurde producten
Produits avec GS qualification



Energie efficiëntiekwalificatie
Qualification d'efficience d'énergie



T5 HE G5 lamp inbegrepen
T5 HE G5 lampe incluse



Spaarlamp niet inbegrepen
Lampe économique non incluse



MycroLynx lamp niet inbegrepen
Lampe MycroLynx non incluse



Niet-dimbaar
Sans variateur



Dimbaar
Avec variateur



Dimbare elektronische ballast
Ballast électronique avec variateur



Kleurtemperatuur lamp
Température de couleur lampe



Gemiddelde levensduur lampen
Durée de vie des lampes



Minimum afstand tot de muur
Distance minimale du mur



Uplighter
Luminosité vers le haut



Opbouwarmatuur
Applique murale



Downlighter
Luminosité vers le bas



Max. aantal armaturen in één lijn
Max. nombre d'armatures en ligne



Budgetvriendelijk
Prix économique



Laag energieverbruik
Basse consommation d'énergie



Makkelijk te installeren
Installation très simple

TREFWOORDENREGISTER REGISTRE DES MOTS-CLES

Accessoires	136-139	Accessoires	136-139
Brandvoorschriften	140	Appliques	127
Byblos	100	Boîte à onglets	136,138
Consolen	116	Byblos	100
DecoFix Extra	137	Chapiteaux	122-126
DecoFix Hydro	137-140	Cheminées décoratives	117
DecoFix Pro	137-140	Cimaises	90-95
Deuromlijstingen	102	Colle d'installation	137-140
Deurpanelen	104	Colonnes	122-125
Duropolymère®	6	Consignes d'incendie	140
Flexibele lijsten	98-99	Consoles	116
Garantie	140	Colles	137
Gesegmenteerde zuil	126	Colonnes	120-125
Hoekelementen	93,95	Colonne segmentée	126
Indirecte verlichting	128-133	Corbeaux → consoles	116
Installatie	138-139	Corniches	80-91
Installatielijm	140	Coupoles	114
Kaderlijsten → wandlijsten	90-95	Dalles de plafond	115
Kapitelen	122-126	DecoFix Extra	137
Koepels	114	DecoFix Hydro	137-140
Kolommen → zuilen	122-125	DecoFix Pro	137-140
Kraagstuk → console	116	Décoration murale	118
Kroonlijsten	80-91	Décoration de plafond	114
Lambrizing	106-107	Duropolymère®	6
LED insert	132	Eclairage	127-133
Light plate	131	Eclairage indirecte	128-133
Lighting string	130	Eléments de coins	93,95
Lijmen	137-140	Eléments décoratifs	118
Lijmpistool	140	Encadrements → cimaises	90-95
Muurdecoratie	118	Encadrements de portes	102
MycroLynx	133	Etagères	116
Nissen	118-119	Fûts de colonnes	122-125
Orac Axxent	97	Garantie	140
Orac Xterio	79	Information de sécurité	140
Orac Luxxus	3-8	Installation	138-139
Panelen	104-105	Lambris	106-107
Pilasters	120-121	LED insert	132
Plafonddecoratie	114	Light plate	131
Plafondtegels	115	Lighting string	130
Plinten	96-97	Moultures flexibles	98-99
Poluyrethaan	6	Murs courbés	98-99
Purotouch®	6	MycroLynx	133
Ronde muren	98-99	Niches	118-119
Rozassen/rozetten	110-113	Orac Axxent	97
Schachten	122-125	Orac Xterio	79
Schappen	116	Orac Luxxus	3-8
Sierelementen	118	Panneaux	104-105
Sierschouwen	117	Panneaux de portes	104
Sokkels	122-125	Peinture	140
T5 Tube	131	Pilastres	120-121
Timpaan → fronton	108-109	Pistolet à colle	140
Variomatic	136	Plinthes	96-97
Veiligheidsinformatie	140	Poluyréthane	6
Verf	140	Purotouch®	6
Verlichting	127-133	Rosaces/rosettes	110-113
Verstekbak	136,138	Scie	136
Voetstukken → sokkels	122-125	Socles	122-125
Wandlampen	127	T5 Tube	131
Wandlijsten	90-95	Tympan → fronton	108-109
Zaag	136	Variomatic	136
Zuilen	122-127	Xinnix®	133
Xinnix®	133		

INDEX REFERENTIES LISTE DES RÉFÉRENCES

B401	116	D161	109	K1141	124	P5020A	91
B402	116	D170	109	K1142	122	P5020B	91
B403	116	D200	102	K1151	124	P5021	90
B404	116	D210	102	K1152	122	P5050	92
B408	116	D300	101, 103	K200	109, 121	P5051	91
B409	116	D310	101	K201	109, 121	P6020	94
B410	116	D320	121	K201LR	121	P7010	94
B413	116	D400	108	K202	121	P7020	94
B414	116	D401	108	K2131	125	P7030	94
B417	116	D402	108	K2132	123	P7040	94
C200	82	D500	104	K220	120	P7050	94
C201	86	D503	104	K221	120	P7060	94
C211	87	D504	104	K223	120	P7070	91
C212	86	D506	104	K224	120	P7080	94
C213	82	D507	104	K240	120	P801C	93
C214	86	D62	102	K241	120	P8020	90
C215	81	DX119	91, 102	K250	121	P8030	90
C216	86	DX121	91, 102	K251	121	P8030C	93
C217	83,84	F10	114	K253	121	P8030D	93
C218	88	F11	114	K254	120, 121	P8040	92
C219	88	F12	114	K255	120	• P8050	92
C220	82	F30	104, 115	K3001	125	P9010	91,101, 103
C230	81	F31	104, 115	K3002	123	P9020	92
C240	82	F32	115	K3101	125	P9040	90
C250	81	F33	115	K3102	123	P9050	90
C260	81	FB10	136	K3111	125	• P9900	90
C300	84	FB13	136	K3112	123	• P9901	90
C301	88	FB14	136	K3141	124	R07	110
C302	87	FB15	136	K3142	123	R08	110
C303	87	FB300	136	K3151	125	R09	110
C304	87	FDP100	136	K3152	123	R10	111
C305	81	FDP500	136	K3201	125	R11	111
C307	89	FDP600	136	K3202	123	R12	111
C307A	89	FDP700	136	K4001	126	R13	111
C308	89	FX200	136	K4002	126	R14	111
C321	83	FX210	136	K4121	126	R16	111
C322	81	G40	118	K4122	126	R17	111
C331	82	G42	118	K4131	126	R18	111
C332	85	G50	118	K4132	126	R22	111
C333	83	G51	118	L501	127	R23	112
C334	83	H100A	117	L504	127	R24	113
• C335	85	H100B	117	L505	127	R27	113
• C336	85	H100C	117	L506	127	R28	112
C351	128	H101A	117	L509	127	R31	111
C352	128	H101B	117	L512	127	R35	111
C353	80	IL000-001	130	L600-001	133	R37	113
C354	80	IL000-002	130	M9010A	101	R38	112
C355	80	IL001-005	131	M9010B	101	R40	110
C356	80	IL001-006	131	M9010C	101	R46	111
C357	128	• IL002-001	131	M9010LR	101	R50	111
C358	128	• IL002-002	131	N403	118	R52	112
C360	80	• IL002-003	131	N404	118	R61	111
C400	82	IL003-001	132	N410	118	R64	113
C402	86	IL003-002	132	N503	119	R66	110
C422	88	IL100	130	N504	119	R73	112
C602	81	IL110	130	N510	119	R74	112
C900	84, 129	• IL120	130	N520	119	R76	110
C901	84, 129	K1001	124	P101A	95	R77	111
C902	83, 129	K1002	122	P1020	94	SX104	97
• C990	84, 85	K1101	124	P20	95	SX105	96
D101	103	K1102	122	P201A	95	SX118	96
D1010	103	K1111	124	P2020	94	SX122	97
D1014	103	K1112	122	P21	95	SX125	97
D102	103	K1121	124	P3020	94	SX137	97
D120	108	K1122	122	P4020	90	SX138	97
D140	109	K1131	124	P4020A	93	SX155	96
D150	109	K1132	122	P5020	91	• SX156	97

• **NEW**



Wij danken iedereen die meegewerkt heeft aan de realisatie van deze brochure.
Nous remercions tout le monde qui a collaboré à la réalisation de ce catalogue.
We would like to thank everybody who helped with the creation of this brochure
Wir danken allen Personen, die an der Herstellung dieser Broschüre mitgewirkt haben.

This catalogue and the designs embodied within are protected by copyright law and international treaties. Unauthorized reproduction of the catalogue or any portion of it or reproduction of any of the designs embodied therein may result in severe civil and criminal penalties and will be prosecuted to the maximum.
All rights reserved. ©2008, ORAC nv.